



Series 2000 Garage Door Price List

01.03.2024

HÖRMANN



HÖRMANN IS ALWAYS COMMITTED TO EXCELLENCE: “In Engineering, in User Safety and in Design.”

All our products are third party tested to the highest standards and are certified to the high safety requirements and performance characteristics of the European Standard 13241-1.

This gives you the reassurance that your purchase of a Hörmann product is a safe investment. We are also committed to our national network of Garage Door Specialist Distributors.

These are independent businesses, who believe in customer service and have skills to advise you on the best product for your property, also providing quality fitting and finishing.

“A great product performs at its best when fitted by experts.”

Door Operating Systems

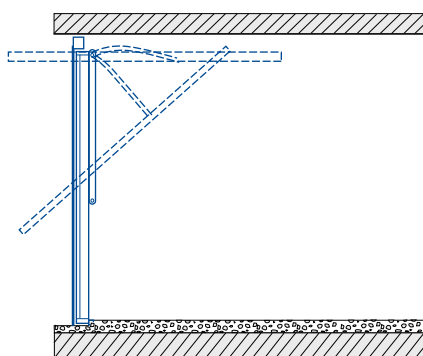

Canopy Operating Gear

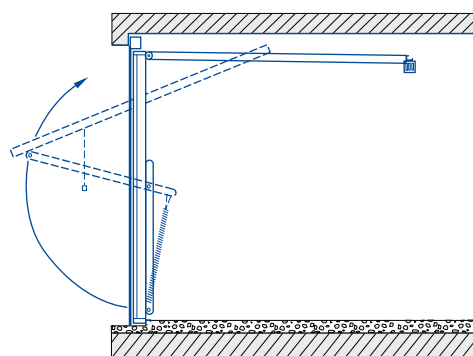

Retractable Operating Gear

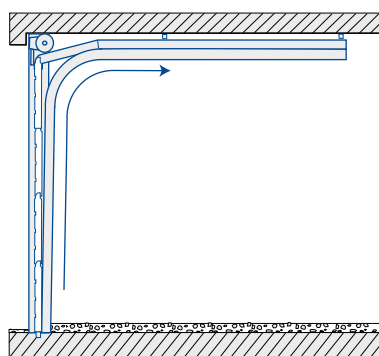



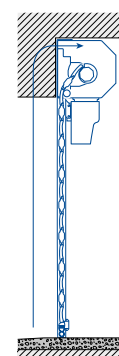

Sectional Operating Gear



RollMatic Operating Gear

We reserve the right to change specification without prior notification.

Contents

	Up-and-over garage doors	Canopy and retractable with steel infill	6
		Canopy and retractable with timber infill	10
	Sectional garage doors	Sectional garage doors LPU 42	16
		Double-skinned steel sectional doors	16
		Slategrain M/L-ribbed sectional doors	16
		Secured by Design	16
		Optional extras and window designs	20
	RollMatic roller garage doors	RollMatic 2	26
		RollMatic T	34
		RollMatic OD	39
		RollMatic side doors	46
		Garage door operators	48
	Door operators	Operator accessories	48
		Hand transmitters	48
		Led light strips	54
		Hörmann homee	55

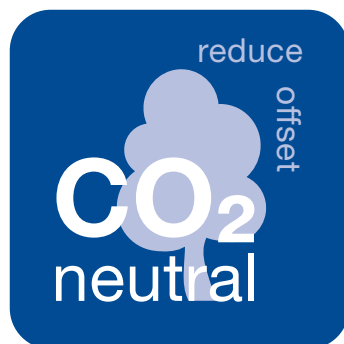

WE THINK AND ACT GREEN. As a family business, we are very conscious of our responsibility to future generations and offer all products for residential construction CO₂-neutral as standard. The Hörmann sustainability strategy aims to reduce and avoid emissions. We cover 100% of our electrical power needs at all European production locations * with genuine green electricity from renewable sources. We also apply many other measures to reduce our consumption and save more than 75000 tonnes of CO₂ each year. We work with ClimatePartner to offset the remaining emissions by supporting certified climate protection projects.



Measuring sheet

For garage doors

Not for pre-fabricated garage doors!

Customer name: _____

Street: _____

Postal code / city: _____

Construction project: _____

Tel.: _____

Fax: _____

Mobile phone: _____

E-mail: _____

Date: _____

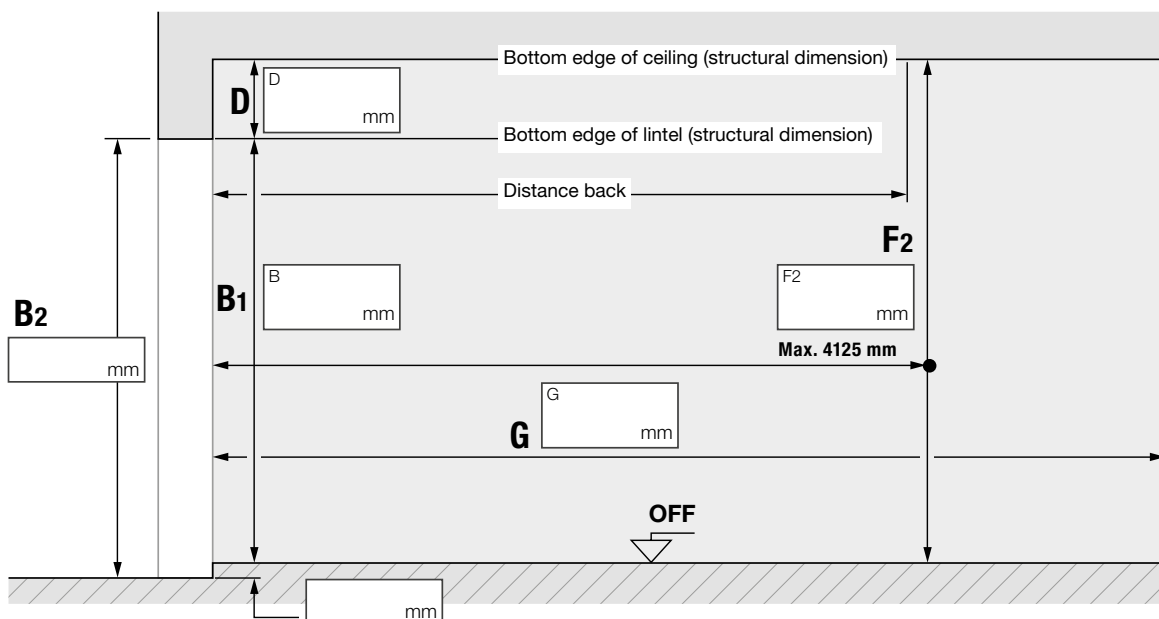
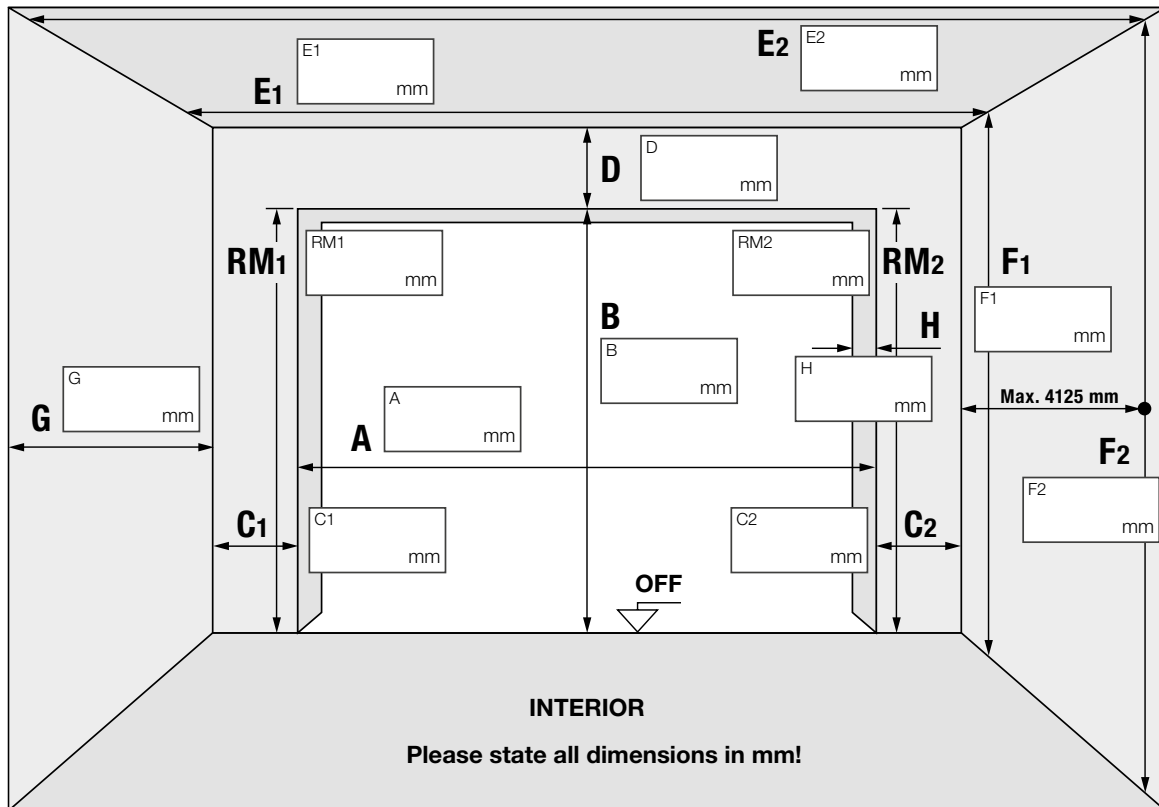

- | | | | | | | | |
|----------------------|-----------------------|----------------------|----------------------------------|----------------------|-------------------------------|-----------------------|--------------|
| A | Clear width | D | Headroom | F₁ | Ceiling height from FFL front | H | Reveal depth |
| B | Clear height from FFL | E₁ | Interior garage dimensions front | F₂ | Ceiling height from FFL back | RM₁ | Left grid |
| C₁ | Left sideroom | E₂ | Interior garage dimensions back | G | Building depth | RM₂ | Right grid |
| C₂ | Right sideroom | | | | | | |

Series 2000 Up-and-Over Doors



Product description

General aspects

Series 2000 doors are available with either canopy, retractable or retractable plus gear and an optional factory fitted steel frame or supplied for fitting to a timber sub-frame. For Series 2000 and side doors to align, further details are required.

Door leaf

Steel leaf chassis with steel infill, boarded timber infill, infill or prepared for infill on site. Door leaf reinforced with 2 steel profiles

Single and double doors with lateral UPVC weather seal as trap guard and sound absorber, fitted to the bottom part of frame and top of door.

Styles with timber infill:

Styles 2005, 2007, 2008, 2009 & 2014:

Built on a plywood backing and supplied with a natural / light oak base-coat treatment.

Styles 2009, 2019, 2013, 2020, 2114, 2019, 2119, 2010, 2110, 2121, & 2122:

Using solid red cedar, main boarding formed using ex 100 x 12 mm boards fixed from the inside (not visible from the outside), also supplied with a base-coat treatment.

Style 2011 Open-for-infill:

Prepared for infill in the frame or overlapping the frame.

Infill weight:

Single doors

min. 6 kg/m²

max. 10 kg/m²

Double doors

min. 6 kg/m²

max. 10 kg/m² standard

View of infill in the frame:

Single doors

Double doors

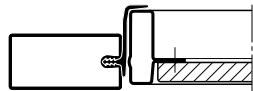
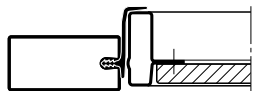

Max. infill thickness for infill overlapping the frame:

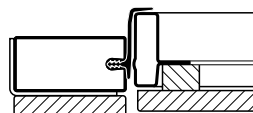

max. 17 mm

for **Single doors:**
16 mm infill thickness
+ 1 mm gap
= 17 mm infill thickness

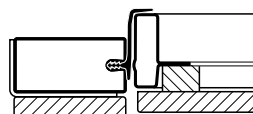

max. 17 mm

for **Double doors:**
16 mm infill thickness
+ 1 mm gap
= 17 mm infill thickness

Dimension of door leaf

Single doors

BR width - 58 mm

BR height - 10 mm

Double doors

BR width - 58 mm

BR height - 10 mm

Steel frame

Single doors: Optional steel box section frame with horizontal tracks, pivot arms etc all pre-fitted.

Double doors: Optional steel box section frame with horizontal tracks, pivot arms etc all pre-fitted.

• Note:

Series 2000 Doors do not include a bottom threshold rail as standard.

Doors can also be fitted to a 70 x 70mm nominal goal post frame (minimum 55mm wide for canopy doors).

Counterbalance

Canopy doors - Single torsion spring shaft fixed to the head frame with cable and rollers running in vertical tracks on the inside frame legs. Spring and vertical tracks incorporate spring and cable break safety system conforming to BS EN 12604.

Retractable doors - Multiple spring safety system: tight coils eliminate the risk of finger trap also conforming to BS EN 12604.

Retractable Plus doors - as retractable doors but with an increased clear drive through height (see data sheet for further information).

Surface protection

Styles with steel infills:

Door leaf made of galvanised material, powder-coated in

• Traffic white, based on RAL 9016,

• Terra brown, based on RAL 8028,

Steel frame powder-coated in the same colour as door.

Styles with timber infills:

Door leaf made of galvanised steel, with powder-coated pre-finished in Terra brown, based on RAL 8028.

All timber doors have natural / light oak base-coat as standard.

Fittings and locking

Round plastic handle on the outside, plastic 'rotary disc' on the inside. Special lock with multi-point locking, with profile half cylinder and release button on the inside, 2-point locking by automatic UPVC-latch (adjustable) 4-point locking option also available.

Standard

Single doors pre-assembled UPVC rollers and UPVC bushes in all door bearings and buffer stop.

Double doors track rollers with ball-bearing.

Delivery

Single doors pre-assembled, 1 unit.

Double doors 3 units: door leaf, frame pack and accessories pack.

Arrangement of fitting anchors

Single doors

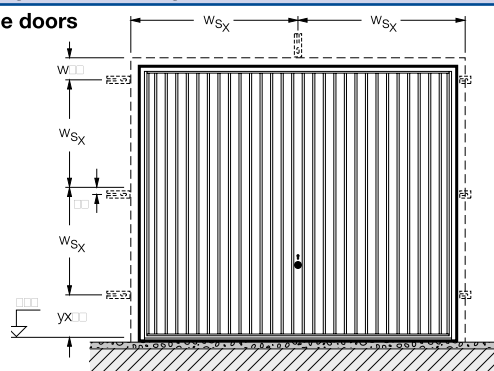

Double doors

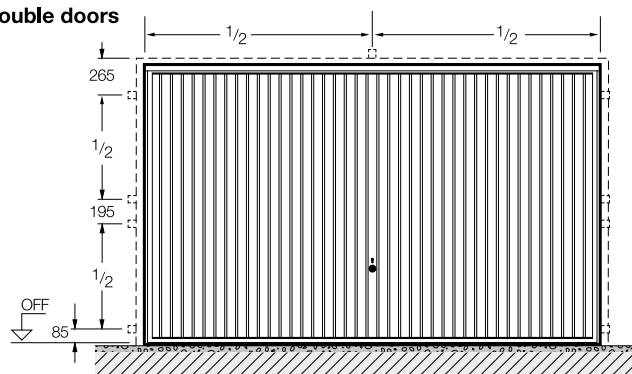

Series 2000 Up-and-Over Doors



Product description

Fitting behind the opening

Single

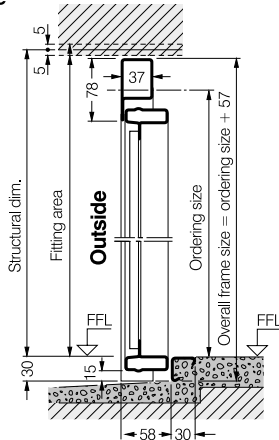

without threshold

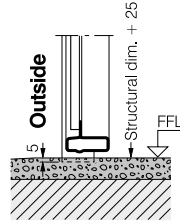

Double

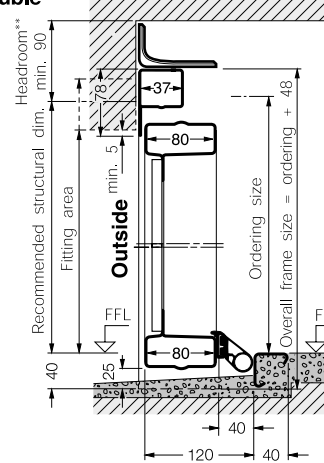

without threshold

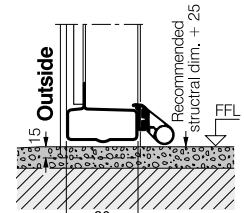

** with operator SupraMatic E/P/H
 Headroom for single door with steel infill min. 50 mm, with timber infill min. 65 mm
 Headroom for double door with steel or timber infill min. 105 mm

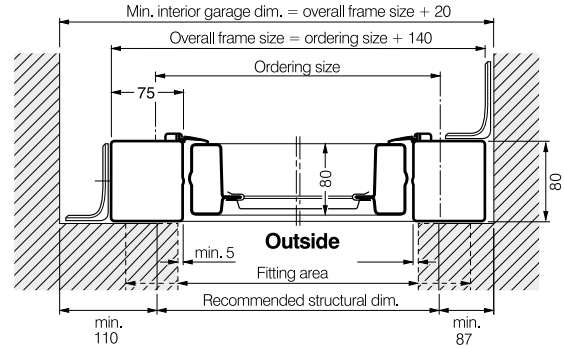
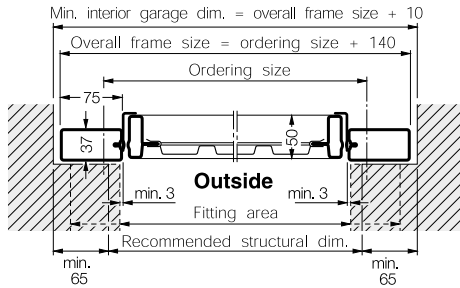

Fitting in the opening

Single

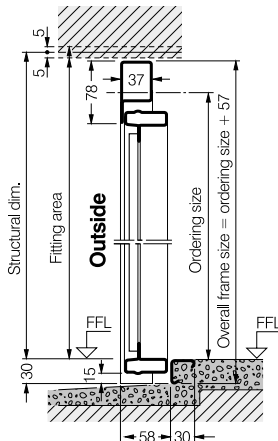

without threshold

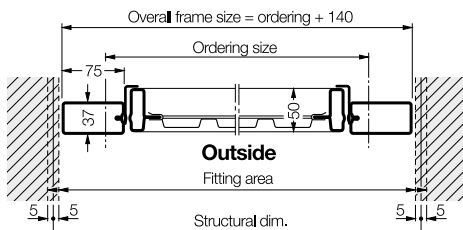
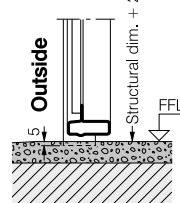

Double

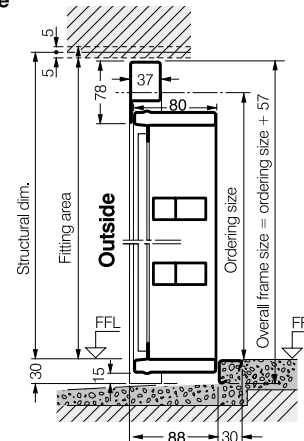

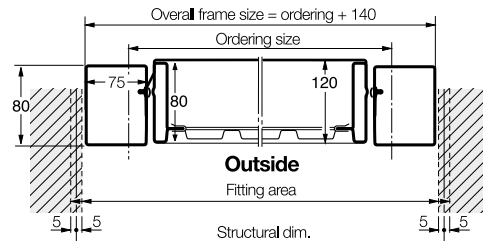
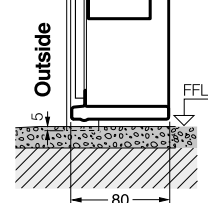

without threshold





Hörmann Up-and-Over Doors

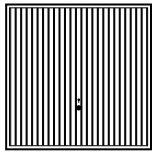
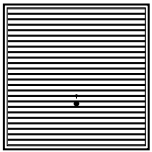
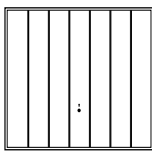
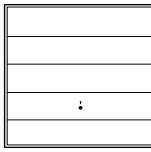

Canopy & retractable with steel infill

SINGLE DOORS											
Door sizes BR		2001 Vertical		2002 Horizontal		2601 Elegance		2602 Finesse		2101 Ilkley	
Imperial	Metric	CAN.	RET.	CAN.	RET.	CAN.	RET.	CAN.	RET.	CAN.	RET.
6'6" x 6'6"	1981 x 1981	966	1023	850	907						
7'0"	1981 x 2134	966	1023	850	907						
6'10" x 6'4"	2083 x 1930	963	1020	868	925						
6'6"	2083 x 1981	963	1020	889	946						
7'0"	2083 x 2134	987	1044	922	979						
7'0" x 6'4"	2134 x 1930	968 ¹	1025 ¹	879	936					1605	1662
6'6"	2134 x 1981	940¹	997¹	850¹	907¹	1190	1247	1190	1247	1605	1662
7'0"	2134 x 2134	973¹	1030¹	890¹	947¹	1255	1312	1255	1312	1621	1678
7'6"	2134 x 2286		1190		1109						
7'3" x 6'4"	2210 x 1930	1017 ¹	1074 ¹	956	1013						
6'6"	2210 x 1981	1021	1078	960	1017						
7'0"	2210 x 2134	1034	1091	970	1027						
7'5" x 6'6"	2261 x 1981	1028	1085	956	1013					1665	1722
7'0"	2261 x 2134	1153	1210	1086	1143					1684	1741
7'6" x 6'4"	2286 x 1930	1050	1107	956	1013					1665	1722
6'6"	2286 x 1981	1050 ¹	1107 ¹	956 ¹	1013 ¹	1318	1375	1318	1375	1665	1722
7'0"	2286 x 2134	1153 ¹	1210 ¹	1090	1147	1518	1575	1518	1575	1684	1741
7'6"	2286 x 2286		1294		1327						
7'8" x 6'4"	2337 x 1930	1189	1246	1098	1155						
8'0" x 6'4"	2438 x 1930	1241	1298	1099	1156					1765	1822
6'6"	2438 x 1981	1241 ¹	1298 ¹	1099	1156	1556	1613	1556	1613	1765	1822
7'0"	2438 x 2134	1284 ¹	1341 ¹	1121	1178	1621	1678	1621	1678	1783	1840
7'6"	2438 x 2286		1456		1295						
8'0"	2438 x 2438		1506		1346						
8'6" x 6'6"	2590 x 1981		1399		1246						
7'0"	2590 x 2134		1518		1290						
9'0" x 6'6"	2743 x 1981		1615		1551						
7'0"	2743 x 2134		1765		1626						
10'0" x 6'6"	3048 x 1981		1958		1942						
7'0"	3048 x 2134		1958		1942						
Prices Marked ¹ – optional Terra brown RAL 8028 available. Surcharge on door, see page 9.											
DOUBLE DOORS Internal frame sizes BR		2001 Vertical		2002 Horizontal		2601 Elegance		2602 Finesse		2101 Ilkley	
Imperial	Metric	Retractable		Retractable		Retractable		Retractable		Retractable	
11'0" x 6'6"	3353 x 1981	2128 *		2128 *							
7'0"	3353 x 2134	2144 *		2144 *							
12'0" x 6'6"	3658 x 1981	2234 *		2234 *							
7'0"	3658 x 2134	2251 *		2251 *							
13'0" x 6'6"	3962 x 1981	2431 *		2431 *							
7'0"	3962 x 2134	2449 *		2449 *							
14'0" x 6'6"	4267 x 1981	2342		2342						3242	
7'0"	4267 x 2134	2342		2342						3242	
Prices Marked * – Not available ex-stock, delivery 4 – 5 weeks											
MATCHING SIDE DOORS Ordering sizes		2001 Vertical		2002 Horizontal		2601 Elegance		2602 Finesse		Style Not Available	
Prices Marked ² – Not available ex-stock, delivery 4 – 8 weeks											
875 x 1875		666		1409 ²		1315 ²		1315 ²			
875 x 2000		666		1409 ²		1315 ²		1315 ²			
875 x 2125		666 ²		1409 ²		1315 ²		1315 ²			
1000 x 2000		705 ²		1454 ²		1504 ²		1504 ²			
1000 x 2125		705		1454 ²		1504 ²		1504 ²			

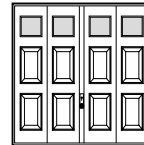
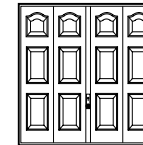
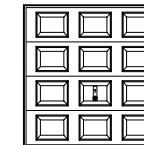

										75mm steel framed doors Recommended structural opening sizes allowing tolerance of 10mm on width & 5mm on height For steel frame options see page 9	
2103 Caxton		2004 Georgian		2304 Georgian with windows		2104 Marquess		2504 Countess		Imperial	Metric
CAN.	RET.	CAN.	RET.	CAN.	RET.	CAN.	RET.	CAN.	RET.		
		1172	1229							7'0" x 6'8½"	2135 x 2044
		1192	1249							7'0" x 7'2¾"	2135 x 2199
		1189	1246							7'4" x 6'6½"	2235 x 1994
		1190	1247							7'4" x 6'8½"	2235 x 2044
		1276	1333							7'4" x 7'2¾"	2235 x 2199
		1190	1247							7'6" x 6'6½"	2284 x 1994
1548	1605	1190 ¹	1247 ¹	1625	1682	1190	1247	1190	1247	7'6" x 6'8½"	2284 x 2044
1556	1613	1255 ¹	1312 ¹	1695	1752	1255	1312	1255	1312	7'6" x 7'2¾"	2284 x 2199
										7'6" x 7'8½"	2284 x 2350
		1318	1375							7'9¼" x 6'6½"	2365 x 1994
										7'9¼" x 6'8½"	2365 x 2044
										7'9¼" x 7'2¾"	2365 x 2199
		1318	1375							7'11" x 6'8½"	2411 x 2044
		1518	1575							7'11" x 7'2¾"	2411 x 2199
		1318	1375							8'0" x 6'6½"	2436 x 1994
		1318 ¹	1375 ¹	1757	1814	1318	1375			8'0" x 6'8½"	2436 x 2044
1654	1711	1518 ¹	1575 ¹	1956	2013	1518	1575			8'0" x 7'2¾"	2436 x 2199
										8'0" x 7'8½"	2436 x 2350
		1578	1635							8'2" x 6'6½"	2489 x 1994
		1556	1613							8'6" x 6'6½"	2589 x 1994
		1556	1613			1556	1613			8'6" x 6'8½"	2589 x 2044
		1621	1678			1621	1678			8'6" x 7'2¾"	2589 x 2199
										8'6" x 7'8½"	2589 x 2350
										8'6" x 8'2¾"	2589 x 2503
										9'0" x 6'8½"	2741 x 2044
										9'0" x 7'2¾"	2741 x 2199
			2038							9'6" x 6'8½"	2894 x 2044
			2073							9'6" x 7'2¾"	2894 x 2199
										10'6" x 6'8½"	3199 x 2044
										10'6" x 7'2¾"	3199 x 2199
Style Not Available		2004 Georgian		2304 Georgian with windows		2104 Marquess		Style Not Available		Imperial	Metric
		Retractable		Retractable		Retractable					
										11'6" x 6'8½"	3504 x 2044
										11'6" x 7'2¾"	3504 x 2199
										12'6" x 6'8½"	3809 x 2044
										12'6" x 7'2¾"	3809 x 2199
										13'6" x 6'8½"	4114 x 2044
										13'6" x 7'2¾"	4114 x 2199
		2522		3181 *		2522 *				14'6" x 6'8½"	4419 x 2044
		2522		3181 *		2522 *				14'6" x 7'2¾"	4419 x 2199
Style Not Available		2004 Georgian		2304 Georgian with windows		2104 Marquess		Style Not Available			
		1315 ²		1547 ²		1315 ²					
		1315 ²		1547 ²		1315 ²					
		1315 ²		1547 ²		1315 ²					
		1504 ²		1736 ²		1504 ²					
		1504 ²		1736 ²		1504 ²					

Hörmann Up-and-Over Doors

Canopy & retractable with steel infill

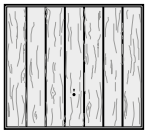
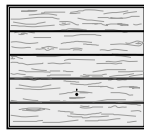
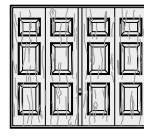
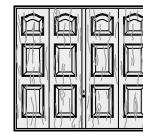
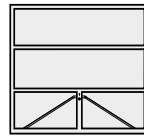

SINGLE DOORS											
Door sizes BR		Vertical Decograin Golden Oak or Rosewood		Horizontal Decograin Golden Oak or Rosewood		Georgian Decograin Golden Oak or Rosewood		Marquess Decograin Golden Oak or Rosewood		2011 Open for infill	
Imperial	Metric	CAN.	RET.	CAN.	RET.	CAN.	RET.	CAN.	RET.	CAN.	RET.
6'6" x 6'6"	1981 x 1981									820	877
7'0"	1981 x 2134									820	877
6'10" x 6'4"	2083 x 1930									820	877
6'6"	2083 x 1981										
7'0"	2083 x 2134										
7'0" x 6'4"	2134 x 1930									820	877
6'6"	2134 x 1981	1208	1265	1076	1133	1421	1478	1421	1478	820	877
7'0"	2134 x 2134	1241	1298	1161	1218	1491	1548	1491	1548	868	925
7'6"	2134 x 2286										
7'3" x 6'4"	2210 x 1930									908	965
6'6"	2210 x 1981										
7'0"	2210 x 2134										
7'5" x 6'6"	2261 x 1981									908	965
7'0"	2261 x 2134									937	994
7'6" x 6'4"	2286 x 1930									908	965
6'6"	2286 x 1981	1285	1342	1190	1247			1578 ⁴	1635 ⁴	908	965
7'0"	2286 x 2134	1385	1442	1323	1380	1820	1877	1820	1877	936	993
7'6"	2286 x 2286										
7'8" x 6'4"	2337 x 1930									951	1008
8'0" x 6'4"	2438 x 1930									951	1008
6'6"	2438 x 1981	1478	1535	1311	1368	1851	1908			951	1008
7'0"	2438 x 2134	1522	1579	1357	1414	1915 ³	1972 ³	1915	1972	951	1008
7'6"	2438 x 2286										
8'0"	2438 x 2438										
8'6" x 6'6"	2590 x 1981										
7'0"	2590 x 2134										
9'0" x 6'6"	2743 x 1981										1108
7'0"	2743 x 2134										1126
10'0" x 6'6"	3048 x 1981										1368
7'0"	3048 x 2134										1368
Prices Marked ³ – Only available in Rosewood. Prices Marked ⁴ – only available in Golden oak											
DOUBLE DOORS Internal frame sizes BR		Style Not Available		Style Not Available		Style Not Available		Style Not Available		2011 Open for infill	
Imperial	Metric									Retractable	
11'0" x 6'6"	3353 x 1981										2695
7'0"	3353 x 2134										2815
12'0" x 6'6"	3658 x 1981										2855
7'0"	3658 x 2134										2959
13'0" x 6'6"	3962 x 1981										2994
7'0"	3962 x 2134										3093
14'0" x 6'6"	4267 x 1981										2798
7'0"	4267 x 2134										2798
Prices Marked * – Not available ex-stock, delivery 4 – 5 weeks											
MATCHING SIDE DOORS Ordering sizes		2001 Golden Oak or Rosewood		2002 Golden Oak or Rosewood		2004 Golden Oak or Rosewood		2104 Golden Oak or Rosewood		2011 Open for infill	
875 x 1875		1454 ²		1454 ²		1454 ²		1454 ²		666	
875 x 2000		1463 ²		1463 ²		1463 ²		1463 ²		666	
875 x 2125		1472 ²		1472 ²		1472 ²		1472 ²		666	
1000 x 2000		1675 ²		1675 ²		1675 ²		1675 ²		705	
1000 x 2125		1683 ²		1683 ²		1683 ²		1683 ²		705	



The door leaf and optional box section steel frame are made of galvanised material that is polyester powder coated on both sides.

This finish is extremely durable and the standard colour is Traffic white RAL 9016.

Other colours are available listed in optional extras below.

To help maintain the aesthetic appearance of your door and prevent the build up of dirt, salt and other corrosive substances the door should be washed with a mild soap-based solution on a regular basis.

If the door is located near the coast it is important that the door panel and frame should be washed at least every 2 months.

We also suggest that all other components are brushed down on a regular basis to prevent the build up of dirt and dust etc.

The window frames on the Georgian and Ilkley doors are UPVC and white as standard.

These frames are a 2-part construction with the window material sandwiched between and frames screwed together from the back for security.

The finish of the Decograin doors is a synthetic foil-coated timber design outside (inside primer white).

The leaf frame and fixing frame is a matching powder coating.

Optional extras for Steel Doors	Price
75mm Steel fixing frame for either canopy or retractable geared single doors. Factory fitted	178
75mm Steel fixing frame for either canopy or retractable geared single doors. Factory fitted with frame to compliment Decograin	178
75mm Steel fixing frame for DOUBLE retractable geared doors, when ordered with the door	278
60mm Steel fixing frame for canopy geared doors only. Factory fitted	183
60mm Steel fixing frame for canopy geared doors only. Factory fitted with frame to compliment Decograin	183
Prices marked ¹ – optional Terra Brown RAL 8028 available. Surcharge on door	53
Retractable plus gear for retractable doors up to 7'6" wide giving extra drive through width	
Surcharge on retractable price. Retractable Plus is not available on some sizes and styles of OFI doors – if required, please check with our sales office prior to order acceptance	94
4 point locking kit for extra security, factory fit with door order or retrofit – single door sizes only	84
3 point locking kit for extra security, factory fit with door (this cannot be retrofitted). Available for 2001 side doors only	149
Window options for 2304 Georgian style door – Plain, crossed or diamond style with crystal glazing	Incl.

Colours are available to special order in the following styles:

2001 Vertical, 2002 Horizontal, 2101 Ilkley available in all the listed sizes

2004 Georgian, 2304 Georgian with windows and 2104 Marquess are available in 7066, 7070, 7566, 7570, 7666, 7670 and 8066, 8070 sizes only (where shown)

2601 Elegance and 2602 Finesse are available in white & Anthracite Grey only

Please note: Caxton and Countess steel up-and-over doors are only available in white

Colours Terra brown RAL 8028, Signal blue RAL 5005, Steel blue RAL 5011, Moss green RAL 6005, Ruby red RAL 3003, Jet black RAL 9005 & Anthracite grey RAL 7016

Includes matching frame if ordered with door. White frame RAL 9016 also available, please specify when ordering

Please allow 5-6 weeks lead time for coloured doors

For an increased range of RAL-to-choose colours in our Series 2000 range of up-and-over garage doors, please ask your Hörmann dealer.	Single doors	168
	Double doors	268

Please consult your Hörmann dealer for steel garage door styles that are available from STOCK in colours: Anthracite grey RAL 7016, Jet black RAL 9005, Moss green RAL 6005 and Steel blue RAL 5011

Coloured window frames for Georgian and Ilkley doors:

Coloured window frames to match door colour

Georgian doors (price per window, see note below for the number of windows) **55**

Ilkley doors (price per single door) **238**

Ilkley doors (price per double door) **466**

Please state coloured windows required on order

Orders received without reference will be supplied with white as standard

Georgian doors up to 10' wide = 4 windows, 11' to 13' = 6 windows, 14' = 8 windows





Please note: Doors with windows may have cross bracing or locking rods passing behind the windows depending upon size and gear type.

Optional handle sets	
Cast Aluminium silver colour	217
Cast Aluminium white	250
Brushed or polished stainless steel	304
Matching lever handles are also available for side doors	P.O.A.



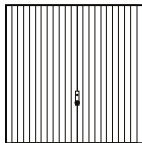

Hörmann Up-and-Over Doors

Canopy & retractable with timber infill

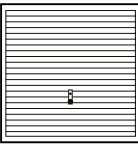
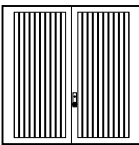

SINGLE DOORS											
Door sizes BR		2005 Measham		2007 Jacobean		2008 Tudor		2014 Rutland		2009 Vertical or Horizontal	
Imperial	Metric	CAN.	RET.	CAN.	RET.	CAN.	RET.	CAN.	RET.	CAN.	RET.
6'6" x 6'6"	1981 x 1981	2336	2393	2812	2869	2812	2869	2812	2869	3203	3260
7'0"	1981 x 2134	2336	2393	2812	2869	2812	2869	2812	2869	3203	3260
6'10" x 6'4"	2083 x 1930	2336	2393	2812	2869	2812	2869	2812	2869	3203	3260
6'6"	2083 x 1981										
7'0"	2083 x 2134										
7'5" x 6'4"	2134 x 1930	2336	2393	2812	2869	2812	2869	2812	2869	3203	3260
6'6"	2134 x 1981	2336	2393	2812	2869	2812	2869	2812	2869	3203	3260
7'0"	2134 x 2134	2336	2393	2812	2869	2812	2869	2812	2869	3203	3260
7'6"	2134 x 2286										
7'3" x 6'4"	2210 x 1930	2428	2485	2943	3000	2943	3000	2943	3000	3319	3376
6'6"	2210 x 1981										
7'0"	2210 x 2134										
7'5" x 6'6"	2261 x 1981	2428	2485	2943	3000	2943	3000	2943	3000	3319	3376
7'0"	2261 x 2134	2607	2664	3033	3090	3033	3090	3033	3090	3395	3452
7'6" x 6'4"	2286 x 1930	2428	2485	2943	3000	2943	3000	2943	3000	3319	3376
6'6"	2286 x 1981	2428	2485	2943	3000	2943	3000	2943	3000	3319	3376
7'0"	2286 x 2134	2483	2540	3033	3090	3033	3090	3033	3090	3395	3452
7'6"	2286 x 2286										
8'0"	2286 x 2438										
7'8" x 6'4"	2337 x 1930	2518	2575	3070	3127	3070	3127	3070	3127	3319	3376
8'0" x 6'4"	2438 x 1930	2561	2618	3104	3161	3104	3161	3104	3161	3509	3566
6'6"	2438 x 1981	2561	2618	3104	3161	3104	3161	3104	3161	3509	3566
7'0"	2438 x 2134	2612	2669	3180	3237	3180	3237	3180	3237	3608	3665
8'0"	2438 x 2438										
8'6" x 6'6"	2590 x 1981										
7'0"	2590 x 2134										
9'0" x 6'6"	2743 x 1981		3067		3551		3551		3551		3793
7'0"	2743 x 2134		3067		3551		3551		3551		3793
10'0" x 6'6"	3048 x 1981		3077		3795		3795		3795		3966
7'0"	3048 x 2134		3077		3795		3795		3795		3966
DOUBLE DOORS Internal frame sizes BR		2005 Measham		2007 Jacobean		2008 Tudor		2014 Rutland		2009 Vertical or Horizontal	
Imperial	Metric	CAN.	RET.	CAN.	RET.	CAN.	RET.	CAN.	RET.	CAN.	RET.
11'0" x 6'6"	3353 x 1981		5424		5984		5984		5984		6388
7'0"	3353 x 2134		5424		5984		5984		5984		6388
12'0" x 6'6"	3658 x 1981		5628		6011		6011		6011		7062
7'0"	3658 x 2134		5628		6011		6011		6011		7062
13'0" x 6'6"	3962 x 1981		5650		6484		6484		6484		7894
7'0"	3962 x 2134		5650		6484		6484		6484		7894
14'0" x 6'6"	4267 x 1981		5658		6381		6381		6381		6617
7'0"	4267 x 2134		5658		6381		6381		6381		6617
Please note: Lead times on all timber garage doors will be 5 to 6 weeks											
MATCHING SIDE DOORS Ordering sizes		2005 Measham		2007 Jacobean		2008 Tudor		2014 Rutland		2009 Vertical or Horizontal	
Imperial	Metric	CAN.	RET.	CAN.	RET.	CAN.	RET.	CAN.	RET.	CAN.	RET.
875 x 1875		1591		1839		1839		1839		1860	
875 x 2000		1591		1839		1839		1839		1860	
875 x 2125		1591		1839		1839		1839		1860	
1000 x 2000		1671		1916		1916		1916		1943	
1000 x 2125		1671		1916		1916		1916		1943	







										75mm steel framed doors Recommended structural opening sizes allowing tolerance of 10mm on width & 5mm on height For steel frame options see page 13	
CAN.	RET.	CAN.	RET.	CAN.	RET.	CAN.	RET.	CAN.	RET.	Imperial	Metric
3197	3254	3705	3762	3705	3762	3705	3762	3826	3883	7'0" x 6'8½"	2135 x 2044
3197	3254	3705	3762	3705	3762	3705	3762	3826	3883	7'0" x 7'2¾"	2135 x 2199
3197	3254	3705	3762	3705	3762	3705	3762	3826	3883	7'4" x 6'6½"	2235 x 1994
										7'4" x 6'8½"	2235 x 2044
										7'4" x 7'2¾"	2235 x 2199
3197	3254	3705	3762	3705	3762	3705	3762	3826	3883	7'6" x 6'6½"	2284 x 1994
3197	3254	3705	3762	3705	3762	3705	3762	3826	3883	7'6" x 6'8½"	2284 x 2044
3197	3254	3705	3762	3705	3762	3705	3762	3826	3883	7'6" x 7'2¾"	2284 x 2199
										7'6" x 7'8½"	2284 x 2350
3319	3376	3823	3880	3823	3880	3823	3880	3992	4049	7'9¼" x 6'6½"	2365 x 1994
										7'9¼" x 6'8½"	2365 x 2044
										7'9¼" x 7'2¾"	2365 x 2199
3319	3376	3823	3880	3823	3880	3823	3880	3992	4049	7'11" x 6'8½"	2411 x 2044
3441	3498	3881	3938	3881	3938	3881	3938	4093	4150	7'11" x 7'2¾"	2411 x 2199
3319	3376	3823	3880	3823	3880	3823	3880	3992	4049	8'0" x 6'6½"	2436 x 1994
3319	3376	3823	3880	3823	3880	3823	3880	3992	4049	8'0" x 6'8½"	2436 x 2044
3441	3498	3881	3938	3881	3938	3881	3938	4177	4234	8'0" x 7'2¾"	2436 x 2199
										8'0" x 7'8½"	2436 x 2350
										8'0" x 8'2¾"	2436 x 2503
3646	3703	4185	4242	4185	4242	4185	4242	4473	4530	8'2" x 6'6½"	2489 x 1994
3646	3703	4185	4242	4185	4242	4185	4242	4473	4530	8'6" x 6'6½"	2589 x 1994
3646	3703	4185	4242	4185	4242	4185	4242	4473	4530	8'6" x 6'8½"	2589 x 2044
3646	3703	4185	4242	4185	4242	4185	4242	4473	4530	8'6" x 7'2¾"	2589 x 2199
										8'6" x 8'2¾"	2589 x 2503
										9'0" x 6'8½"	2741 x 2044
										9'0" x 7'2¾"	2741 x 2199
	4167		4754		4754		4754		4884	9'6" x 6'8½"	2894 x 2044
	4167		4754		4754		4754		4884	9'6" x 7'2¾"	2894 x 2199
	4545		5060		5060		5060		5429	10'6" x 6'8½"	3199 x 2044
	4545		5060		5060		5060		5429	10'6" x 7'2¾"	3199 x 2199
2109 Mallory		2013 Caxton		2020 Gatcombe		2114 Shepshed		2019 Garage Light		Imperial	Metric
CAN.	RET.	CAN.	RET.	CAN.	RET.	CAN.	RET.	CAN.	RET.		
	6721		7096		7096		7096		7900	11'6" x 6'8½"	3504 x 2044
	6721		7096		7096		7096		7900	11'6" x 7'2¾"	3504 x 2199
	7289		7713		7713		7713		8686	12'6" x 6'8½"	3809 x 2044
	7289		7713		7713		7713		8686	12'6" x 7'2¾"	3809 x 2199
	7909		8430		8430		8430		9780	13'6" x 6'8½"	4114 x 2044
	7909		8430		8430		8430		9780	13'6" x 7'2¾"	4114 x 2199
	7681		8199		8199		8199		9266	14'6" x 6'8½"	4419 x 2044
	7681		8199		8199		8199		9266	14'6" x 7'2¾"	4419 x 2199
2109 Mallory		2013 Caxton		2020 Gatcombe		2114 Shepshed		2019 Garage Light			
CAN.	RET.	CAN.	RET.	CAN.	RET.	CAN.	RET.	CAN.	RET.		
2097		2215					2156		2469		
2097		2215					2156		2469		
2097		2215					2156		2469		
2182		2299					2239		2546		
2182		2299					2239		2546		

Hörmann Up-and-Over Doors

Canopy & retractable with timber infill

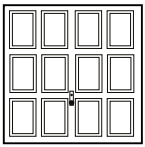

SINGLE DOORS										75mm steel framed doors Recommended structural opening sizes allowing tolerance of 10mm on width & 5mm on height For steel frame options see page 13	
Door sizes BR		2119 Leicester		2010 Chevron		2121 Chesterfield		2122 Middleton		Imperial	Metric
Imperial	Metric	CAN.	RET.	CAN.	RET.	CAN.	RET.	CAN.	RET.	Imperial	Metric
6'6" x 6'6"	1981 x 1981		4384	3952	4009		5010		4967	7'0" x 6'8½"	2135 x 2044
7'0"	1981 x 2134		4384	3952	4009		5010		4967	7'0" x 7'2¾"	2135 x 2199
6'10" x 6'4"	2083 x 1930		4384	3952	4009		5010		4967	7'4" x 6'6½"	2235 x 1994
6'6"	2083 x 1981									7'4" x 6'8½"	2235 x 2044
7'0"	2083 x 2134									7'4" x 7'2¾"	2235 x 2199
7'0" x 6'4"	2134 x 1930		4417	3952	4009		5010		4967	7'6" x 6'6½"	2284 x 1994
6'6"	2134 x 1981		4417	3952	4009		5010		4967	7'6" x 6'8½"	2284 x 2044
7'0"	2134 x 2134		4417	3952	4009		5043		5023	7'6" x 7'2¾"	2284 x 2199
7'6"	2134 x 2286									7'6" x 7'8½"	2284 x 2350
7'3" x 6'4"	2210 x 1930		4816	4127	4184		5377		5360	7'9¼" x 6'6½"	2365 x 1994
6'6"	2210 x 1981									7'9¼" x 6'8½"	2365 x 2044
7'0"	2210 x 2134									7'9¼" x 7'2¾"	2365 x 2199
7'5" x 6'6"	2261 x 1981		4839	4127	4184		5388		5360	7'11" x 6'8½"	2411 x 2044
7'0"	2261 x 2134		5023	4240	4297		5409		5388	7'11" x 7'2¾"	2411 x 2199
7'6" x 6'4"	2286 x 1930		4835	4127	4184		5388		5360	8'0" x 6'6½"	2436 x 1994
6'6"	2286 x 1981		4835	4127	4184		5388		5360	8'0" x 6'8½"	2436 x 2044
7'0"	2286 x 2134		5023	4240	4297		5440		5409	8'0" x 7'2¾"	2436 x 2199
7'6"	2286 x 2286									8'0" x 7'8½"	2436 x 2350
8'0"	2286 x 2438									8'2" x 6'6½"	2436 x 2503
7'8" x 6'4"	2337 x 1930		5153	4505	4562					8'6" x 6'6½"	2489 x 1994
8'0" x 6'4"	2438 x 1930		5175	4505	4562					8'6" x 6'8½"	2589 x 1994
6'6"	2438 x 1981		5175	4505	4562					8'6" x 7'2¾"	2589 x 2044
7'0"	2438 x 2134		5287	4575	4632					8'6" x 7'8½"	2589 x 2199
8'0"	2438 x 2438									8'6" x 8'2¾"	2589 x 2503
8'6" x 6'6"	2590 x 1981									9'0" x 6'8½"	2741 x 2044
7'0"	2590 x 2134									9'0" x 7'2¾"	2741 x 2199
9'0" x 6'6"	2743 x 1981		5423		4931					9'6" x 6'8½"	2894 x 2044
7'0"	2743 x 2134		5423		4931					9'6" x 7'2¾"	2894 x 2199
10'0" x 6'6"	3048 x 1981		6108		5741					10'6" x 6'8½"	3199 x 2044
7'0"	3048 x 2134		6108		5741					10'6" x 7'2¾"	3199 x 2199
DOUBLE DOORS Internal Frame Sizes BR		2119 Leicester		2010 Chevron		Style Not Available		Style Not Available		Imperial	Metric
BR	RET.	CAN.	RET.	CAN.	RET.	CAN.	RET.	CAN.	RET.	Imperial	Metric
11'0" x 6'6"	3353 x 1981		8506		8142					11'6" x 6'8½"	3504 x 2044
7'0"	3353 x 2134		8506		8142					11'6" x 7'2¾"	3504 x 2199
12'0" x 6'6"	3658 x 1981		9097		8294					12'6" x 6'8½"	3809 x 2044
7'0"	3658 x 2134		9097		8294					12'6" x 7'2¾"	3809 x 2199
13'0" x 6'6"	3962 x 1981		9956		8430					13'6" x 6'8½"	4114 x 2044
7'0"	3962 x 2134		9956		8430					13'6" x 7'2¾"	4114 x 2199
14'0" x 6'6"	4267 x 1981		9713		8199					14'6" x 6'8½"	4419 x 2044
7'0"	4267 x 2134		9713		8199					14'6" x 7'2¾"	4419 x 2199
Please note: Lead times on all timber garage doors will be 5 to 6 weeks											
MATCHING SIDE DOORS Ordering Sizes		2119 Leicester		2010 Chevron		2121 Chesterfield		2122 Middleton		Imperial	Metric
Ordering Sizes		CAN.	RET.	CAN.	RET.	CAN.	RET.	CAN.	RET.	Imperial	Metric
875 x 1875		1891		1839		1839		1891			
875 x 2000		1891		1839		1839		1891			
875 x 2125		1891		1839		1839		1891			
1000 x 2000		1943		1916		1916		1943			
1000 x 2125		1943		1916		1916		1943			

Our timber garage doors are constructed as an infill to fit into the Open-for-Infill Up-and-Over door frame, this gives the doors their rigid and durable construction.

The styles Measham, Jacobean, Tudor and Rutland are cedar facings glued and fixed to exterior quality plywood.

The solid cedar doors are 12mm tongue and groove boards constructed as an infill.

Cedar is organically grown with natural colour and grain variations; this is a feature of cedar.

We make every effort to harmonise the effect where possible, by hand matching the component parts used in construction.

Please note a uniform overall grain pattern cannot be guaranteed.

Protection (Basecoat)

All our timber doors are supplied with a dip immersion coat of Remmers Induline GW306 base stain primer 006 Light Oak; this coating is for temporary protection only.

If purchased in this temporary finish, please ensure that a full specification of finishing coats are applied immediately before or after installation to all exposed surfaces - inside as well as outside - with a Remmers or similar finishing coat system.

A fully finished option is available, please see options below.

For further choice of exciting door designs, traditional or contemporary in Nordic Pine and Hemlock, with a vast range of sizes, ask your garage door specialist about the N 80 Up-and-Over garage doors available to special order.

Optional extras for timber doors	Price
75mm Steel fixing frame for either canopy or retractable geared single doors, factory fitted Terra brown RAL 8028 as standard	178
75mm Steel fixing frame for DOUBLE retractable geared doors Terra brown RAL 8028 as standard when ordered with the door	278
60mm Steel fixing frame for canopy geared doors only, factory fitted Terra brown RAL 8028 as standard	183
Retractable plus gear for retractable doors up to 7'6" wide giving extra drive through width Surcharge on retractable price. Retractable Plus is not available on some sizes and styles of timber doors – if required, please check with our sales office prior to order acceptance	94
4 point locking kit for extra security, factory fit with door order or retrofit	84
Window options for 2019 Garage Light door - Crystal or clear glazing and can be plain or with square or diamond simulated leading	Incl.

Fully finished option

This is available as a factory process giving a 5 year erosion protection

The product used is Remmers and is available in the following stain colours:

Mahogany, Walnut, Dark Oak, Medium Oak, Light Oak, Teak, Rosewood and Golden Oak

For south facing situations exposed to strong sunlight, the dark colours are NOT recommended as they can store excessive heat and dry out

	Stain finish	Traffic white RAL 9016/Ebony	RAL to choose
Door sizes up to 8'0" x 7'0"	170	291	387
Door sizes up to 14'0" x 7'0"	387	519	951
Side Doors	127	262	327

Optional handle sets

Cast Aluminium silver colour	217
Cast Aluminium white	250
Brushed or polished stainless steel	304
Matching lever handles are also available for side doors	P.O.A.

Sectional doors LPU 42 – steel



Product description

Applies to all registered LPU 42/67 unmodified sectional garage doors, using a Hörmann operator and fitted behind the opening. To register your door, email us at info@hormann.co.uk.

Views

(The illustrations correspond to size 2500 × 2125 mm. Deviations may occur with other sizes.)

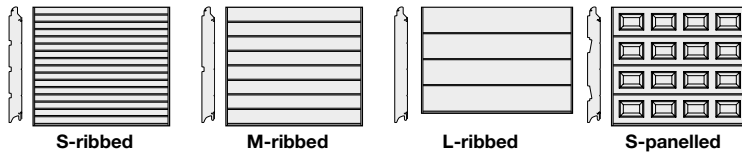

General

Sectional garage doors for private purposes. Prepared for Hörmann garage door operators, 10 door cycles per day in accordance with the guarantee conditions.

Door leaf

With finger trap protection on outside and inside.

Door sections made of double-skinned steel sections, 42 mm thick, made of hot-galvanized sheet steel, PU-foamed.

- S-ribbed *Woodgrain*-embossed on exterior
- M-ribbed *Woodgrain*-embossed, *Slategrain*-embossed, *Sandgrain*, *Silkgrain* or *Decograin* on exterior
- L-ribbed *Woodgrain*-embossed, *Slategrain*-embossed, *Sandgrain*, *Planar*, *Silkgrain*, *Decograin* or *Duragrain* on exterior
- S-panelled *Woodgrain*-embossed or *Decograin* on exterior

Thermal insulation value:

- Section 42 mm $U = 0.5 \text{ W}/(\text{m}^2\cdot\text{K})$
 - Fitted door 42 mm (without ThermoFrame) * $U = 1.4 \text{ W}/(\text{m}^2\cdot\text{K})$
 - Fitted door 42 mm (with ThermoFrame) * $U = 1.2 \text{ W}/(\text{m}^2\cdot\text{K})$
- * Without glazing, door size 5000 × 2250 mm

Versions:

Any door height divided in even door sections (except intermediate heights).

- S- or M-ribbed: horizontal increments evenly spaced in height
- L-ribbed
- S-panelled: panel arrangement evenly spaced in width

The number and division of the panels in an LPU 42 door may deviate from an LPU 42 door with wicket door!

Bottom door section with bottom seal as standard.

Note on door leaf reinforcement:

Solar radiation may result in deflection of the door elements and foam break. To reduce the possibility of section deflection caused by sun exposure, all doors from LZ > 5000 mm are equipped at the factory with the door leaf reinforcement set.

From LZ > 4500 mm, the following colours and decors are equipped at the factory with the door leaf reinforcement set.

- RAL colours

RAL 3007 Black red	RAL 6022 Olive drab
RAL 5003 Sapphire blue	RAL 7016 Anthracite grey
RAL 5004 Black blue	RAL 7021 Black grey
RAL 5011 Steel blue	RAL 7043 Traffic grey
RAL 5013 Cobalt blue	RAL 8014 Sepia brown
RAL 5020 Ocean blue	RAL 8016 Mahogany brown
RAL 5022 Night blue	RAL 8017 Chocolate brown
RAL 6004 Blue green	RAL 8019 Grey brown
RAL 6005 Moss green	RAL 8022 Black brown
RAL 6007 Bottle green	RAL 8028 Terra brown
RAL 6008 Brown green	RAL 9004 Signal black
RAL 6009 Fir green	RAL 9005 Jet black
RAL 6012 Black green	RAL 9011 Graphite black
RAL 6015 Black olive	RAL 9017 Traffic black
- Colour CH 703
- Noir 2100 Sablé (Anthracite metallic)
- Planar CH 7016 Matt deluxe Anthracite grey, CH 8028 Matt deluxe Terra brown and CH 703 Matt deluxe Anthracite metallic
- Decograin decors Dark Oak, Night Oak, Rosewood and Titan Metallic CH 703
- Duragrain decors Sapeli, Terra Walnut, Mocca, Grigio scuro, Rusty Steel, Burned Oak, Cherry, Rusty Oak, Noce Sorrento Balsamico

Colours and decors that have not been listed may be ordered with the door leaf reinforcement set as optional equipment.

In case of any doubt, we recommend ordering the reinforcement as an option for doors under thermal loads not equipped with a door leaf reinforcement at the factory.

Door leaf reinforcements limit section deflection, but do not prevent it completely.

The use of a SupraMatic is recommended for doors with operator and door leaf reinforcements.

Frame

- **Frame** with trap guard, made of hot-galvanized sheet steel, *Woodgrain*-embossed, with side seal and plastic frame shoe. Standard version: Frame with polyester-primer coating in Traffic white, based on RAL 9016; galvanized tracks, suspensions and connection rail. Premium version: Frame, tracks, suspensions and connection rail in Grey white based on RAL 9002.
- **Fascia panel, single-skinned, with seal to make up for insufficient headroom up to 100 mm**
 - in *Woodgrain*-embossed with *Woodgrain* doors.
 - In smooth for *Slategrain*-embossed, *Sandgrain*, *Planar*, *Silkgrain* and *Decograin*.

Fascia panel in door colour for doors in RAL 9016, Color, Color Matt deluxe, RAL to choose and Noir 2100 Sablé.

 - in *Decograin* (with plastic film coating, for possible decors see page 19).
 - in *Duragrain* as standard in *Woodgrain* RAL 9016 (optionally available in a colour matching the decor).
- **Frame covering, single-skinned** (optional for a surcharge) required for fitting in the reveal in the versions:
 - in *Woodgrain*-embossed, *Sandgrain*, *Planar*, *Silkgrain* or *Decograin*
 - In smooth for *Slategrain*-embossed or *Duragrain*

For possible surface coating (colours / decors), see product description on page 19. Please state desired colour / decor on order!

Counterbalance

- Tension spring assembly: with lateral integral double tension springs with 2 cables on each side
 - up to door width 3250 mm and door height 2625 mm,
 - up to door width 3500 mm and door height 2375 mm,
 - up to door width 4000 mm and door height 2250 mm
- Torsion spring assembly: Torsion spring assembly with cable drums and approved spring safety device as well as integral lateral cables
 - from door width 3251 mm and door height 2625 mm,
 - from door width 3501 mm and door height 2375 mm,
 - from door width 4001 mm and door height 2250 mm

Tension springs and torsion springs are galvanized.

Sectional doors LPU 42 – steel



Product description

Applies to all registered LPU 42/67 unmodified sectional garage doors, using a Hörmann operator and fitted behind the opening. To register your door, email us at info@hormann.co.uk.

Fittings and closing devices

As standard without door handle set and lock. The door handle sets to be ordered separately are supplied including a template for an on-site lock knock-out. A factory lock knock-out will result in a longer delivery time and must be ordered explicitly.

If a sectional door without door handle set and lock is equipped with an operator, an emergency release is required if there is no second entrance!

Fitting parts

As standard, the fitting parts are galvanized.

Premium version

The following components are supplied in RAL 9002:

- Door leaf fittings
- Side frames
- Horizontal tracks incl. connection rail and double radius
- Defined accessory parts

Version with break-in-resistant fitting RC 2

Break-in-resistant sectional garage door LPU 42 according to DIN / TS 18194 RC 2 with and without wicket door.

- Only for doors with operator!
- Fitting behind the reveal only!
- For track applications Z, N and L only!
- 2nd entrance to the garage required!
- Premium version possible.

Surface coating of door leaf

Woodgrain, Slategrain and Silkgrain version with polyester-primer coating on both sides

Interior:

- Grey white, based on RAL 9002

Exterior:

- Traffic white as standard, based on RAL 9016
 - Color, preferred colours based on the RAL CLASSIC colour chart
- | | | | |
|----------|-----------------|----------|-----------------|
| RAL 1015 | Light ivory | RAL 7035 | Light grey |
| RAL 6005 | Moss green | RAL 7039 | Quartz grey |
| RAL 6009 | Fir green | RAL 7040 | Window grey |
| RAL 7012 | Basalt grey | RAL 8028 | Terra brown |
| RAL 7015 | Slate grey | RAL 9005 | Jet black |
| RAL 7016 | Anthracite grey | RAL 9006 | White aluminium |
| RAL 7030 | Stone grey | RAL 9007 | Grey aluminium |
- Hörmann colour CH 703 (Anthracite metallic)
- Noir 2100 Sablé
 - RAL to choose*, based on the RAL CLASSIC colour chart
 - Special colours on request (other colour systems, such as NCS or DB* colours and colour 8077)

Not available: RAL colours 4006, 4007 and 9021 as well as pearl-effect colours and fluorescent colours.

* In wicket door version in Silkgrain, the following RAL and DB colours are not available:

DB: 701, 702

RAL: 3007, 5004, 7021, 8022, 9004, 9011, 9017, 8077

Version with exterior polyester final coating. For doors with Woodgrain, Slategrain or Silkgrain surface finish (clear varnish)

Final coating:

- Increase of weather protection and prevention of chalking.
- No increase in corrosion protection in the area of cutting edges.

Final coating "Anti-graffiti":

- Simple removal of graffiti by using GraffitiX from the manufacturer Matecra. Available from specialised retailers.
- Increase of weather protection and prevention of chalking.
- No increase in corrosion protection in the area of cutting edges.

Note:

The polyester final coating gives the coated surface a more matt appearance. A direct combination of primed and final coated products should be avoided due to the varying gloss levels!

Sandgrain version with polyester-primer coating on both sides

Interior:

- Grey white, based on RAL 9002

Exterior:

- Traffic white as standard, based on RAL 9016
 - Color, preferred colours based on the RAL CLASSIC colour chart
- RAL 7016 Anthracite grey

Other colours and RAL to choose are not possible!

Planar version with polyester-primer coating on both sides

Interior:

- Grey white, based on RAL 9002

Exterior:

- Standard Traffic white, in CH 9016 Matt deluxe
- Color Matt deluxe based on the RAL CLASSIC colour chart

CH 9006 Matt deluxe	White aluminium
CH 9007 Matt deluxe	Grey aluminium
CH 7016 Matt deluxe	Anthracite grey
CH 8028 Matt deluxe	Terra brown
CH 703 Matt deluxe	Anthracite metallic
CH905 Matt deluxe	Black

Other colours and RAL to choose are not possible!

Version with Duragrain coating on exterior

Interior:

- Polyester-primer coating, Grey white, based on RAL 9002

Exterior:

- Coating in Duragrain decor with high-strength coating, authentic surface finish look.

Bamboo	Rusty Oak
Beige	Rusty Steel
Concrete	Sapele
Burned Oak	Sheffield
Cherry	Teak
Spruce	Weathered Look
Grigio	Colonial Walnut
Grigio scuro	Terra Walnut
Malt Oak	White brushed
Mocca	White Oak
Nature Oak	White Oiled Oak
Noce Sorrento Balsamico	Whitewashed Oak
Noce Sorrento Nature	

Colours matching Duragrain

The frame covering and glazing frames are coated in a colour matching the decor. A surcharge on RAL 9016 is charged for a matching colour panel.

Duragrain coating version with individual print on exterior

Interior:

- Polyester-primer coating, Grey white, based on RAL 9002

Exterior:

- Coating in Duragrain individual print with high-strength coating, authentic surface finish look.

Colours matching Duragrain

The colour of the coating on accessory parts (e.g. the frame covering, single-skinned panel and glazing frame) are individually specified by the customer.

Notes:

- Technical feasibility inspection in the factory (on request).
- Not possible for fixed elements, doors with wicket door, chamfered adjustment and PU panels of all kinds.

Decograin version with plastic film coating on the exterior

Interior:

- Polyester-primer coating, Grey white, based on RAL 9002

Exterior:

- Coated with timber design plastic film with embossed timber structure for authentic timber character.

Golden Oak:	Medium-brown, golden yellow oak design
Dark Oak:	Walnut-coloured oak design
Night Oak:	Dark brown oak design
Rosewood:	Mahogany-coloured timber design
Winchester Oak:	Natural-coloured knotty oak design

- Coated with plastic film in **Titan Metallic CH 703** (only for M- or L-ribbed sectional doors)

Colours matched to Decograin

The glazing frames are coated in a colour matching the decor.

Hörmann Sectional Doors

LPU 42 – double-skinned doors with steel sections – 42mm



Single doors with Z track tension springs giving low headroom as standard

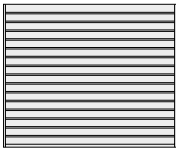
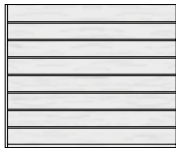
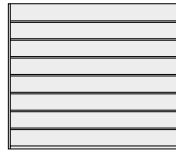

SINGLE DOORS							
Door sizes BR		S-ribbed Woodgrain		M-ribbed Woodgrain/Slategrain		M-ribbed Sandgrain	
Imperial	Metric	Outside White	Outside Colour*	Outside White	Outside Colour*	Outside White	Outside Colour*
6'10" x 6'6"	2080 x 2000	1391	1629	1391	1629	1485	1723
6'10" x 6'10"	2080 x 2080	1444	1691	1444	1691	1545	1792
7'0" x 6'6"	2134 x 2000	1441	1685	1441	1685	1485	1729
7'0" x 7'0"	2134 x 2125	1491	1750	1491	1750	1545	1804
7'6" x 6'6"	2286 x 2000	1441	1702	1441	1702	1485	1746
7'6" x 7'0"	2286 x 2125	1491	1768	1491	1768	1545	1822
7'6" x 7'4"	2286 x 2250	1511	1805	1511	1805	1617	1911
7'6" x 7'9"	2286 x 2375	1630	1940	1630	1940	1687	1997
7'6" x 8'2"	2286 x 2500	1626	1952	1626	1952	1751	2077
8'0" x 6'6"	2438 x 2000	1516	1794	1516	1794	1569	1847
8'0" x 7'0"	2438 x 2125	1576	1872	1576	1872	1639	1935
8'0" x 7'4"	2438 x 2250	1576	1889	1576	1889	1688	2001
8'0" x 7'9"	2438 x 2375	1663	1994	1663	1994	1762	2093
8'0" x 8'2"	2438 x 2500	1666	2014	1666	2014	1809	2157
8'6" x 6'6"	2591 x 2000	1516	1812	1516	1812	1569	1865
8'6" x 7'0"	2591 x 2125	1576	1890	1576	1890	1639	1953
9'0" x 6'6"	2740 x 2000	1642	1955	1642	1955	1711	2024
9'0" x 7'0"	2740 x 2125	1699	2031	1699	2031	1782	2114
9'6" x 6'6"	2896 x 2000	1715	2046	1715	2046	1799	2130
9'6" x 7'0"	2896 x 2125	1786	2137	1786	2137	1874	2225
10'0" x 6'6"	3048 x 2000	1657	2005	1657	2005	1799	2147
10'0" x 7'0"	3048 x 2125	1718	2088	1718	2088	1874	2244

*For information on outside colour, see page 15

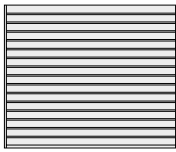
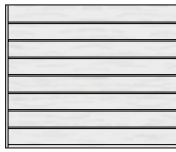
Double doors with N track springs (see shaded area of grid). For low headroom see bottom of page 19

DOUBLE DOORS							
Door sizes BR		S-ribbed Woodgrain		M-ribbed Woodgrain/Slategrain		M-ribbed Sandgrain	
Imperial	Metric	Outside White	Outside Colour*	Outside White	Outside Colour*	Outside White	Outside Colour*
11'0" x 6'6"	3353 x 2000	1956	2339	1956	2339	2140	2523
11'0" x 7'0"	3353 x 2125	2035	2442	2035	2442	2223	2630
12'0" x 6'6"	3658 x 2000	2260	2678	2260	2678	2388	2806
12'0" x 7'0"	3658 x 2125	2327	2771	2327	2771	2467	2911
13'0" x 6'6"	3962 x 2000	2382	2834	2382	2834	2478	2930
13'0" x 7'0"	3962 x 2125	2454	2934	2454	2934	2569	3049
14'0" x 6'6"	4267 x 2000	2474	2961	2474	2961	2548	3035
14'0" x 7'0"	4267 x 2125	2574	3091	2574	3091	2651	3168
14'6" x 6'6"	4420 x 2000	2558	3062	2558	3062	2611	3115
14'6" x 7'0"	4420 x 2125	2661	3197	2661	3197	2719	3255
15'0" x 6'6"	4572 x 2000	2605	3127	2605	3127	2631	3153
15'0" x 7'0"	4572 x 2125	2707	3261	2707	3261	2744	3298
15'6" x 6'6"	4725 x 2000	2715	3254	2715	3254	2679	3218
15'6" x 7'0"	4725 x 2125	2806	3379	2806	3379	2786	3359
16'0" x 6'6"	4877 x 2000	2715	3271	2715	3271	2729	3285
16'0" x 7'0"	4877 x 2125	2824	3415	2824	3415	2836	3427

Intermediate sizes are available, please see your dealer for more details

Hörmann Sectional Doors

LPU 42 – double-skinned doors with steel sections – 42mm



Single doors with Z track tension springs giving low headroom as standard

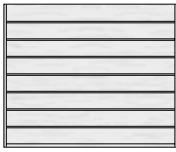
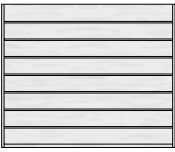
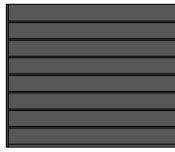

SINGLE DOORS							
Door sizes BR		M-ribbed Silkgrain		M-ribbed Decograin		M-ribbed Titan Metallic CH 703	
Imperial	Metric	Outside White	Outside Colour*	Outside Timber Design*		Outside Titan Metallic CH 703*	
6'10" x 6'6"	2080 x 2000	1712	1950	1883	1883		
6'10" x 6'10"	2080 x 2080	1780	2027	1958	1958		
7'0" x 6'6"	2134 x 2000	1712	1956	1883	1883		
7'0" x 7'0"	2134 x 2125	1780	2039	1958	1958		
7'6" x 6'6"	2286 x 2000	1712	1973	1883	1883		
7'6" x 7'0"	2286 x 2125	1780	2057	1958	1958		
7'4" x 7'4"	2286 x 2250	1862	2156	2049	2049		
7'9" x 7'9"	2286 x 2375	1943	2253	2139	2139		
8'2" x 8'2"	2286 x 2500	2020	2346	2225	2225		
8'0" x 6'6"	2438 x 2000	1813	2091	1997	1997		
8'0" x 7'0"	2438 x 2125	1891	2187	2084	2084		
8'0" x 7'4"	2438 x 2250	1946	2259	2144	2144		
8'0" x 7'9"	2438 x 2375	2038	2369	2247	2247		
8'0" x 8'2"	2438 x 2500	2087	2435	2301	2301		
8'6" x 6'6"	2591 x 2000	1813	2109	1997	1997		
8'6" x 7'0"	2591 x 2125	1891	2205	2084	2084		
9'0" x 6'6"	2740 x 2000	1987	2300	2195	2195		
9'0" x 7'0"	2740 x 2125	2066	2398	2282	2282		
9'6" x 6'6"	2896 x 2000	2093	2424	2315	2315		
9'6" x 7'0"	2896 x 2125	2176	2527	2407	2407		
10'0" x 6'6"	3048 x 2000	2093	2441	2315	2315		
10'0" x 7'0"	3048 x 2125	2176	2546	2407	2407		

*For information on outside colour, see page 15

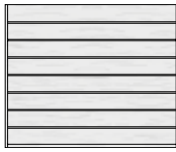
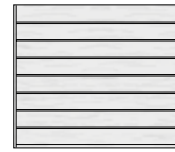
Double doors with N track springs (see shaded area of grid). For low headroom see bottom of page 19

DOUBLE DOORS							
Door sizes BR		M-ribbed Silkgrain		M-ribbed Decograin		M-ribbed Titan Metallic CH 703	
Imperial	Metric	Outside White	Outside Colour*	Outside Timber Design*		Outside Titan Metallic CH 703*	
11'0" x 6'6"	3353 x 2000	2504	2887	2780	2780		
11'0" x 7'0"	3353 x 2125	2605	3012	2893	2893		
12'0" x 6'6"	3658 x 2000	2804	3222	3120	3120		
12'0" x 7'0"	3658 x 2125	2894	3338	3220	3220		
13'0" x 6'6"	3962 x 2000	2911	3363	3241	3241		
13'0" x 7'0"	3962 x 2125	3023	3503	3366	3366		
14'0" x 6'6"	4267 x 2000	2997	3484	3338	3338		
14'0" x 7'0"	4267 x 2125	3120	3637	3476	3476		
14'6" x 6'6"	4420 x 2000	3074	3578	3426	3426		
14'6" x 7'0"	4420 x 2125	3200	3736	3567	3567		
15'0" x 6'6"	4572 x 2000	3097	3619	3452	3452		
15'0" x 7'0"	4572 x 2125	3231	3785	3601	3601		
15'6" x 6'6"	4725 x 2000	3159	3698	3522	3522		
15'6" x 7'0"	4725 x 2125	3281	3854	3658	3658		
16'0" x 6'6"	4877 x 2000	3214	3770	3584	3584		
16'0" x 7'0"	4877 x 2125	3343	3934	3729	3729		

Intermediate sizes are available, please see your dealer for more details

Hörmann Sectional Doors

LPU 42 – double-skinned doors with steel sections – 42mm

Single doors with Z track tension springs giving low headroom as standard

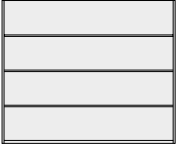
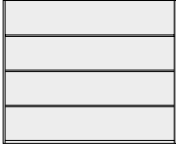
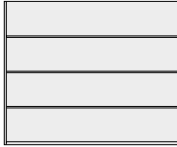
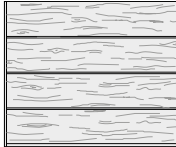

SINGLE DOORS								
Door sizes BR		L-ribbed Slategrain		L-ribbed Sandgrain		L-ribbed Silkgrain		L-ribbed Decograin
Imperial	Metric	Outside White	Outside Colour*	Outside White	Outside Colour*	Outside White	Outside Colour*	Outside Timber Design*
6'10" x 6'6"	2080 x 2000	1527	1765	1730	1968	1918	2156	2106
6'10" x 6'10"	2080 x 2080	1585	1832	1754	2001	1942	2189	2131
7'0" x 6'6"	2134 x 2000	1586	1830	1730	1974	1918	2162	2106
7'0" x 7'0"	2134 x 2125	1641	1900	1754	2013	1942	2201	2131
7'6" x 6'6"	2286 x 2000	1586	1847	1730	1991	1918	2179	2106
7'6" x 7'0"	2286 x 2125	1641	1918	1754	2031	1942	2219	2131
7'4" x 7'4"	2286 x 2250	1660	1954	1827	2121	2029	2323	2226
7'9" x 7'9"	2286 x 2375	1792	2102	1838	2148	2037	2347	2233
8'2" x 8'2"	2286 x 2500	1787	2113	1886	2212	2087	2413	2289
8'0" x 6'6"	2438 x 2000	1669	1947	1827	2105	2026	2304	2227
8'0" x 7'0"	2438 x 2125	1737	2033	1862	2158	2069	2365	2273
8'0" x 7'4"	2438 x 2250	1733	2046	1903	2216	2109	2422	2316
8'0" x 7'9"	2438 x 2375	1834	2165	1993	2324	2211	2542	2429
8'0" x 8'2"	2438 x 2500	1833	2181	1996	2344	2212	2560	2429
8'6" x 6'6"	2591 x 2000	1669	1965	1827	2123	2026	2322	2227
8'6" x 7'0"	2591 x 2125	1737	2051	1862	2176	2069	2383	2273
9'0" x 6'6"	2740 x 2000	1812	2125	2005	2318	2230	2543	2456
9'0" x 7'0"	2740 x 2125	1877	2209	2031	2363	2263	2595	2491
9'6" x 6'6"	2896 x 2000	1896	2227	2114	2445	2355	2686	2597
9'6" x 7'0"	2896 x 2125	1976	2327	2145	2496	2389	2740	2633
10'0" x 6'6"	3048 x 2000	1832	2180	2114	2462	2355	2703	2597
10'0" x 7'0"	3048 x 2125	1898	2268	2145	2515	2389	2759	2633

* For information on outside colour, see page 15.

Double doors with N track springs (see shaded area of grid). For low headroom see bottom of page 19

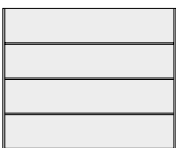
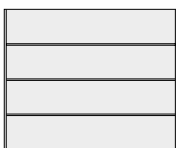
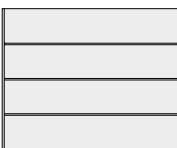
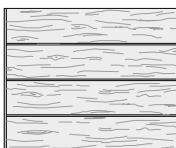
DOUBLE DOORS								
Door sizes BR		L-ribbed Slategrain		L-ribbed Sandgrain		L-ribbed Silkgrain		L-ribbed Decograin
Imperial	Metric	Outside White	Outside Colour*	Outside White	Outside Colour*	Outside White	Outside Colour*	Outside Timber Design*
11'0" x 6'6"	3353 x 2000	2170	2553	2501	2884	2802	3185	3099
11'0" x 7'0"	3353 x 2125	2259	2666	2543	2950	2844	3251	3145
12'0" x 6'6"	3658 x 2000	2520	2938	2658	3076	2979	3397	3298
12'0" x 7'0"	3658 x 2125	2591	3035	2680	3124	3003	3447	3323
13'0" x 6'6"	3962 x 2000	2658	3110	2859	3311	3207	3659	3554
13'0" x 7'0"	3962 x 2125	2737	3217	2932	3412	3293	3773	3650
14'0" x 6'6"	4267 x 2000	2763	3250	2997	3484	3369	3856	3737
14'0" x 7'0"	4267 x 2125	2874	3391	3049	3566	3426	3943	3800
14'6" x 6'6"	4420 x 2000	2856	3360	3080	3584	3462	3966	3842
14'6" x 7'0"	4420 x 2125	2973	3509	3132	3668	3517	4053	3901
15'0" x 6'6"	4572 x 2000	2908	3430	3115	3637	3500	4022	3884
15'0" x 7'0"	4572 x 2125	3027	3581	3165	3719	3556	4110	3946
15'6" x 6'6"	4725 x 2000	3037	3576	3167	3706	3565	4104	3958
15'6" x 7'0"	4725 x 2125	3142	3715	3224	3797	3627	4200	4026
16'0" x 6'6"	4877 x 2000	3037	3593	3226	3782	3628	4184	4029
16'0" x 7'0"	4877 x 2125	3157	3748	3283	3874	3694	4285	4101

Intermediate sizes are available, please see your dealer for more details

Hörmann Sectional Doors

LPU 42 – double-skinned doors with steel sections – 42mm

Single doors with Z track tension springs giving low headroom as standard

Secured by Design



Police Preferred Specification



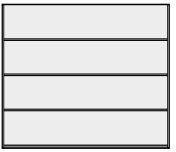
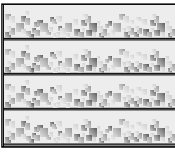
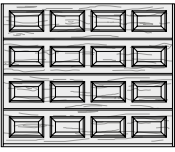

SINGLE DOORS		 L-ribbed Titan Metallic CH703 Outside Titan Metallic CH703*	 L-ribbed Planar Outside White Outside Colour*		 L-ribbed Duragrain Outside Decor Coating*	 S-panelled Woodgrain Outside White Outside Colour* No. of panels		
Door sizes BR			Outside Titan Metallic CH703*	Outside White	Outside Colour*	Outside Decor Coating*	Outside White	Outside Colour*
Imperial	Metric							
6'10" x 6'6"	2080 x 2000	2106	1730	1968	2106	1760	1998	4
6'10"	2080 x 2080	2131	1754	2001	2131	1782	2029	4
7'0" x 6'6"	2134 x 2000	2106	1730	1974	2106	1821	2065	4
7'0"	2134 x 2125	2131	1754	2013	2131	1846	2105	4
7'6" x 6'6"	2286 x 2000	2106	1730	1991	2106	1821	2082	4
7'0"	2286 x 2125	2131	1754	2031	2131	1846	2123	4
7'4"	2286 x 2250	2226	1827	2121	2226	1840	2134	4
7'9"	2286 x 2375	2233	1838	2148	2233	1964	2274	4
8'2"	2286 x 2500	2289	1886	2212	2289	1961	2287	4
8'0" x 6'6"	2438 x 2000	2227	1827	2105	2227	1879	2157	4
7'0"	2438 x 2125	2273	1862	2158	2273	1953	2249	4
7'4"	2438 x 2250	2316	1903	2216	2316	1940	2253	4
7'9"	2438 x 2375	2429	1993	2324	2429	2065	2396	4
8'2"	2438 x 2500	2429	1996	2344	2429	2062	2410	4
8'6" x 6'6"	2591 x 2000	2227	1827	2123	2227	1921	2217	4
7'0"	2591 x 2125	2273	1862	2176	2273	1953	2267	4
9'0" x 6'6"	2740 x 2000	2456	2005	2318	2456	2092	2405	4
7'0"	2740 x 2125	2491	2031	2363	2491	2123	2455	4
9'6" x 6'6"	2896 x 2000	2597	2114	2445	2597	2196	2527	5
7'0"	2896 x 2125	2633	2145	2496	2633	2239	2590	5
10'0" x 6'6"	3048 x 2000	2597	2114	2462	2597	2108	2456	5
7'0"	3048 x 2125	2633	2145	2515	2633	2153	2523	5

* For information on outside colour, see below & page 15.

All coloured doors are special order only – 4 to 8 weeks delivery. Please note: the prices listed as Outside Colour are for the following colours only: RAL 1015, 6005, 6009, 7012, 7015, 7016, 7030, 7035, 7039, 7040, 8028, 9005, 9006 and 9007 & CH703 Anthracite metallic. Special RAL colours are available, please ask your garage door specialist.

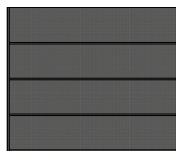
Double doors with N track springs (see shaded area of grid). For low headroom see bottom of page

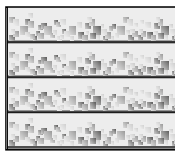
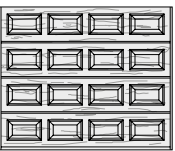
DOUBLE DOORS		 L-ribbed Titan Metallic CH703 Outside Titan Metallic CH703*	 L-ribbed Planar Outside White Outside Colour*		 L-ribbed Duragrain Outside Decor Coating*	 S-panelled Woodgrain Outside White Outside Colour* No. of panels		
Imperial	Metric		Outside Titan Metallic CH703*	Outside White	Outside Colour*	Outside Decor Coating*	Outside White	Outside Colour*
11'0" x 6'6"	3353 x 2000	3099	2501	2884	3099	2519	2902	5
7'0"	3353 x 2125	3145	2543	2950	3145	2564	2971	5
12'0" x 6'6"	3658 x 2000	3298	2658	3076	3298	2934	3352	6
7'0"	3658 x 2125	3323	2680	3124	3323	3011	3455	6
13'0" x 6'6"	3962 x 2000	3554	2859	3311	3554	3091	3543	6
7'0"	3962 x 2125	3650	2932	3412	3650	3135	3615	6
14'0" x 6'6"	4267 x 2000	3737	2997	3484	3737	3216	3703	7
7'0"	4267 x 2125	3800	3049	3566	3800	3267	3784	7
14'6" x 6'6"	4420 x 2000	3842	3080	3584	3842	3330	3834	7
7'0"	4420 x 2125	3901	3132	3668	3901	3387	3923	7
15'0" x 6'6"	4572 x 2000	3884	3115	3637	3884	3394	3916	7
7'0"	4572 x 2125	3946	3165	3719	3946	3449	4003	7
15'6" x 6'6"	4725 x 2000	3958	3167	3706	3958	3431	3970	7
7'0"	4725 x 2125	4026	3224	3797	4026	3534	4107	7
16'0" x 6'6"	4877 x 2000	4029	3226	3782	4029	3527	4083	7
7'0"	4877 x 2125	4101	3283	3874	4101	3609	4200	7

Low headroom

Door with track application L, torsion spring at the back

£

174

Intermediate sizes are available, please see your dealer for more details

Hörmann Sectional Doors



Optional extras for sectional doors

Colour surcharge	Price
RAL to choose colours (please ask to see colour chart)	per m ² 93
Door leaf in special colours (please ask to see colour chart)	per m ² 183

Fittings	Article no.	Price
The below listed handle sets are supplied with:		
• Lock with profile half cylinder with side locking		
• Template for lock knock-out on site		
A factory lock knock-out will result in a longer delivery time and must be ordered explicitly (State position on order!)		

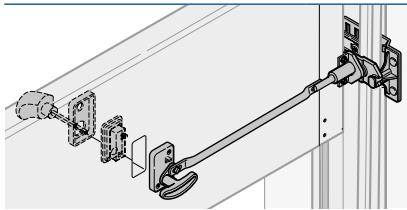

Door handle set, black plastic, prepared for profile cylinder	4015100	Each	85
Door handle set, cast aluminium RAL 9016, prepared for profile cylinder	3060831	Each	235
Door handle set, brown cast aluminium, prepared for profile cylinder	3076054	Each	235
Door handle set, brushed stainless steel, prepared for profile cylinder	3060835	Each	235

Emergency release	Price
Emergency release for sectional doors with handle set (Please state at point of order)	Each 56
Emergency release for sectional doors without handle set (Please state at point of order)	Each 53

Special anchor set	Article no.	Price
Set of 8 special anchors for side frame fitting up to LZ = 5500 mm	3056482	per set 75

Reinforces the complete frame in difficult fitting situations

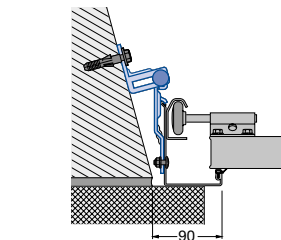

Unevenness can be accommodated without having to use packing or subframe

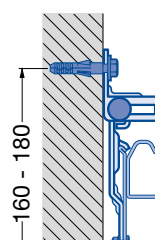

Fitting in the opening without additional posts (Frame covering must also be ordered)

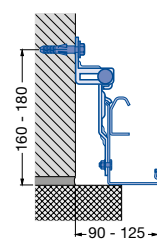

Fitting behind brickwork risk-free

Frame cover profiles matching the colour of the door – 55mm x 19.5mm and 90mm x 19.5mm: prices are per pair

Door heights	White RAL 9016								Colour							
	Woodgrain		Sandgrain		Planar		Silkgrain/Slategrain		Woodgrain		Sandgrain		Planar		Silkgrain/Slategrain	
	55mm	90mm	55mm	90mm	55mm	90mm	55mm	90mm	55mm	90mm	55mm	90mm	55mm	90mm	55mm	90mm
2000mm	88	122	94	132	94	132	94	132	102	152	124	158	124	158	124	158
2080mm	92	127	98	138	98	138	98	138	107	159	129	165	129	165	129	165
2125mm	94	130	100	141	100	141	100	141	109	162	132	168	132	168	132	168
2250mm	99	138	106	149	106	149	106	149	115	171	140	178	140	178	140	178
2375mm	105	145	112	157	112	157	112	157	122	181	148	188	148	188	148	188
2500mm	110	153	118	165	118	165	118	165	128	190	155	198	155	198	155	198

Frame cover profiles matching the colour of the door – 55mm x 19.5mm and 90mm x 19.5mm: prices are per pair

Door heights	RAL to choose/CH 703				Decograin/Titan Metallic CH 703		Duragrain	
	Woodgrain		Silkgrain/Slategrain		Decograin/Titan Metallic CH 703		Duragrain	
	55mm	90mm	55mm	90mm	55mm	90mm	55mm	90mm
2000mm	146	216	152	234	136	172	136	172
2080mm	152	225	159	244	142	179	142	179
2125mm	156	230	162	249	145	183	145	183
2250mm	165	243	171	264	153	194	153	194
2375mm	174	257	181	278	162	205	162	205
2500mm	183	270	190	293	170	215	170	215

For all available colours and finishes please refer to page 14. Duragrain - New smooth matching surface coating in Duragrain.

Retrofit fascias

Door heights	White RAL 9016				Colour				RAL to choose/CH 703		Decograin/Titan Metallic CH 703	Duragrain
	Woodgrain	Sandgrain	Planar	Silkgrain/Slategrain	Woodgrain	Sandgrain	Planar	Silkgrain/Slategrain	Woodgrain	Silkgrain/Slategrain	Decograin/Titan Metallic CH 703	Duragrain
Set: Renovation fascias to cover damaged brickwork edges consisting of: 3 angle sections, 69/40mm, each 3000mm long												
Price	230	250	250	250	291	310	310	310	328	348	261	261
Set: Fascia frame -95- consisting of: 2 fascias, 95mm, 2800mm long, 1 fascia 95mm, 3200mm long, fixing material												
Price	267	284	284	284	327	344	344	344	365	382	292	292

Hörmann Sectional Doors



Glazing options for sectional doors

LPU 42 with 16mm (for panelled) or 22mm (for ribbed) double pane in clear (DS) or crystal structure (DK)

Glazings			£/each
S0		With synthetic double pane, 16 mm or 22mm, clear / clear or crystal structure / crystal structure	LPU 42 148
S1		With synthetic double pane, 16 mm or 22mm, clear / clear or crystal structure / crystal structure	LPU 42 183
S2		With synthetic double pane, 16 mm or 22mm, clear / clear or crystal structure / crystal structure	LPU 42 183
S 10 – S 60		With synthetic double pane, 16 mm or 22mm, clear / clear or crystal structure / crystal structure	LPU 42 188
M0		<ul style="list-style-type: none"> With synthetic double pane, 22 mm, Clear / clear or crystal structure / crystal structure 	LPU 42 180
For door width and glazing configuration, please refer to the 01-24 A price list			
Type D		<ul style="list-style-type: none"> With synthetic double pane, clear / clear or crystal structure / crystal structure, 16 mm 	LPU 42 148
For door width and glazing configuration, please refer to the 01-24 A price list			

Sunrise Glazing			£/section
S10		<ul style="list-style-type: none"> With synthetic double pane, 16 mm or 22mm Clear / clear or crystal structure / crystal structure 	For LPU 42 (4 × £188) 752
LPU 42 Door width 2130 mm up to 2750 mm			
S20		<ul style="list-style-type: none"> With synthetic double pane, 16 mm or 22mm Clear / clear or crystal structure / crystal structure 	For LPU 42 (5 × £188) 940
LPU 42 Door width 2755 mm up to 3500 mm			
S30		<ul style="list-style-type: none"> With synthetic double pane, 16 mm or 22mm Clear / clear or crystal structure / crystal structure 	For LPU 42 (6 × £188) 1128
LPU 42 Door width 3505 mm up to 4000 mm			
S40		<ul style="list-style-type: none"> With synthetic double pane, 16 mm or 22mm Clear / clear or crystal structure / crystal structure 	For LPU 42 (7 × £188) 1316
LPU 42 Door width 4005 mm up to 4750 mm			
S50		<ul style="list-style-type: none"> With synthetic double pane, 16 mm or 22mm Clear / clear or crystal structure / crystal structure 	For LPU 42 (8 × £188) 1504
LPU 42 Door width 4755 mm up to 5500 mm			
S60		<ul style="list-style-type: none"> With synthetic double pane, 16 mm or 22mm Clear / clear or crystal structure / crystal structure 	For LPU 42 (8 × £188) 1504
LPU 42 Door width 4755 mm up to 5500 mm			

Standard Colour Surcharges for the above windows. Please note: front window frame only is painted			Price
Standard colour for Decograin/Duragrain/Planar	For glazing S0, S1, S2 & M0 & type D	Each	40
	For Sunrise glazing × No. of frames for width of door	Each	47
RAL to choose	For glazing S0, S1, S2 & M0 & type D	Each	68
	For Sunrise glazing × No. of frames for width of door	Each	85

Roller garage door RollMatic 2

Including operator

Roller garage door RollMatic 2 product description



General

Spring-compensated roller garage door for private applications. As standard, only when the Hörmann operator RollMatic is used, version as internal roller garage door or external roller garage door, max. 10 door cycles per day according to the warranty conditions.

Frame

- Aluminium extrusion profile side guides with integrated slider profile and brush seal. Coating in door curtain colour.
 - Decopaint version:
Colours matching the Decopaint surface finish.
 - Decograin version – fitting behind the opening:
Colours matching the Decograin surface finish.
 - Decograin version – fitting in the opening:
Plastic film coating in colour of door curtain.
- Lintel and curtain cover made of sheet steel, coated in door curtain colour.
 - Decopaint / Decograin version:
Colours matching the Decopaint / Decograin surface finish.
- Side cladding made of sheet steel, coating in the door curtain colour.
 - Decopaint / Decograin version:
Colours matching the Decopaint / Decograin surface finish.

Door curtain

Rolled aluminium profile foamed with polyurethane rigid foam with integrated wind locks, profile height 77 mm. Coloured versions with two-layer coil coating with a paint system based on a high-quality polyurethane coated with polyamide.

Notice:

All Hörmann roller garage doors correspond to their technical properties and use state-of-the-art paint systems. Pressure marks and abrasive wear are design-related and cannot be avoided. They do not impair the function and the durability of the roller garage door.

Surface coating

Version in standard colours

Interior and exterior of door curtain:

- Standard colours based on the RAL colour chart:

RAL 9016 Traffic white	RAL 7016 Anthracite grey
RAL 1015 Light ivory	RAL 7035 Light grey
RAL 3003 Ruby red	RAL 8028 Terra brown
RAL 3004 Purple red	RAL 9001 Cream
RAL 5011 Steel blue	RAL 9005 Jet black
RAL 6005 Moss green	RAL 9006 White aluminium
RAL 7015 Slate grey	RAL 9007 Grey aluminium
- Chartwell Green
- Noir 2100 Sablé (Anthracite metallic) – at a surcharge

Dark colours should not be used for doors that are exposed to the sun.

IMPORTANT:

Our garage doors RollMatic are made of different materials. Particularly in the case of darker colours based on RAL 7015, RAL 7035, RAL 7016, RAL 8028, RAL 9005, RAL 9006 or RAL 9007 as well as the colour Noir 2100 Sablé, a differentiated colour perception between the sections and other coloured components of the door may occur depending on the lighting on-site. Such colour deviations do not warrant a complaint.

Decopaint version with paint in timber design look

Interior and exterior of door curtain:

- Golden Oak** – medium brown, yellow-gold surface with vibrant oak character
- Rosewood** – reddish-brown stripey timber design

Decograin version

with plastic film coating with timber design (not available for external roller garage doors)

Door curtain, exterior:

- Coated with UV-resistant plastic film with timber design with embossed grain for authentic timber character.
 - Golden Oak** – medium brown, yellow-gold surface with vibrant oak character
 - Rosewood** – reddish-brown stripey timber design

Door curtain, interior:

- Terra brown coating based on RAL 8028

Counterbalance

Tension spring assembly with lateral integral double tension springs. Cladding of internal roller garage door with transparent plastic and with aluminium profiles with integrated window cut-outs for external roller garage doors. Transmission of forces via two cables.

Manually operated version (not possible with external roller garage door)

Door operated via chain hoist and interior / exterior handle.

Fittings and closing devices

Lockable bottom profile with two-point locking for manually operated doors. Locking with operator RollMatic.

Chamfered bottom weather seal (optional, not available for manual operation)

Optional bottom profile to compensate for uneven floors (up to 300 mm height difference). Standard colour Jet black RAL 9005. Optional coating available in door curtain colour (with the exception of Decopaint and Decograin).

Delivery

1 unit including operator / chain hoist

Glazing and / or ventilation grille arrangement (optional)

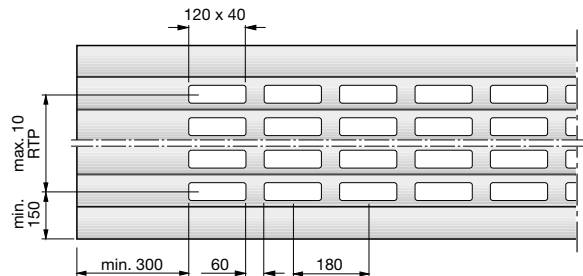

Notice:

- Glazing / ventilation arrangement is only possible starting at the 2nd section from the bottom.
- For technical reasons, the glazing / ventilation arrangement in the curtain is only possible starting at the 8th visible section from the top.

max. = Maximum

min. = At least

RTP = Rolling shutter lath

Roller garage door RollMatic 2

Including operator

Operator RollMatic 2 product description

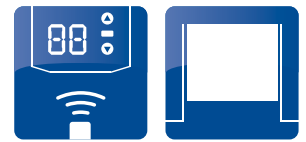

Roller garage door operator RollMatic



Operator RollMatic series 2



Control RollMatic series 2
In a separate housing

- Internal roller garage door: operator always on left when viewed from inside
- External roller garage door: standard operator left, right can be selected (not shown), integrated in the curtain cover



**RollMatic
Series 2**

Operator incl. control	Price in £	Included in the door price
Product description		
Door cycles (Open / Close)	Per day / per hour	25 / 10
Suitable for:	<ul style="list-style-type: none"> • The industrial sector • Max. door width • Max. door leaf surface 	<p>–</p> <p>6000</p> <p>15 m²</p>
Operator data		
Motor		24 V DC gear drive
Mains voltage		230 V – 240 V AC
Power input		0.5 kW
Opening speed ³⁾		max. 20 cm/s ³⁾
Standby		< 1 W
Housing		<ul style="list-style-type: none"> • Plastic housing with an external operator. • Integrated in curtain cover for external roller garage doors.
Temperature range		–20°C to +60°C
Protection category		Only for dry rooms
Control electronics		
Display		Double 7-segment display
Operation and programming		Control element with Open / Close / PRG buttons
Impulse control		●
Adjustable power limit		●
Adjustable soft start and soft stop		●
Adjustable operator light / partial opening / ventilation position		●
Adjustable automatic timer		5 – 300 sec.
Adjustable automatic timer / partial opening		5 – 240 min.
Adjustable / pre-set operator light		30 – 600 sec. / 120 sec.
High-speed opening		●
Equipment		
Hand transmitter (868 MHz)		2 X 4-button hand transmitter HSE 4 BS, textured surface (black) with chrome caps
Integrated receiver (868 MHz)		Bi-directional 7-channel receiver BS
Integrated Bluetooth® receiver (2.4 GHz)		●
LED lighting		●
Connection for photocell / closing edge safety device		● / ●
Connection of external control elements		●
Connection for emergency battery		●
Connecting lead with CEE plug		●
Closing edge safety device		Roller garage door LB > 5000 mm – optical closing edge safety device installed at the factory in the bottom profile ensures safety as per DIN EN 13241-1, closing edge safety device with spiral cable

Notice:

Installation of a photocell is required if the automatic timer is activated!

For optional extras see the Door operators section, See door operators section in the 01-24 A Dealer Price List

Roller garage door RollMatic 2

Including operator

Internal roller garage door fitting dimensions



Fitting behind the opening

Operator / chain hoist interior left

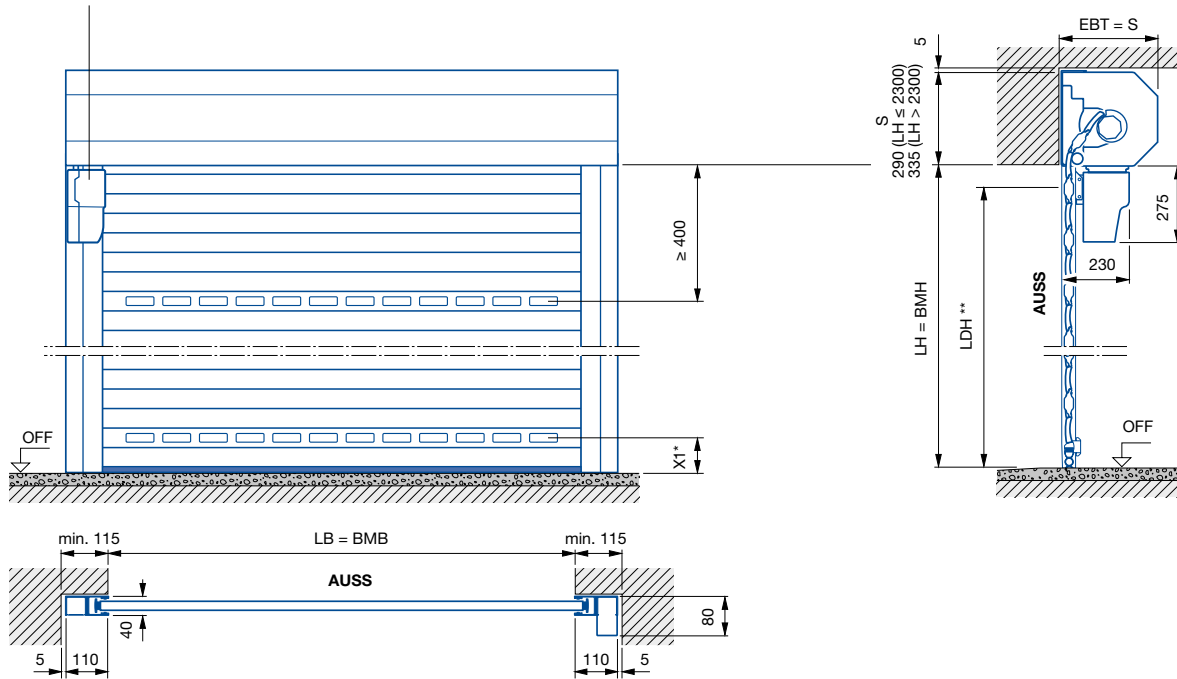

* X1 – min. 150 mm (dimension without chamfered bottom profile)

** See the table “Dimensions” on page 25

Fitting in the opening

Operator / chain hoist interior left

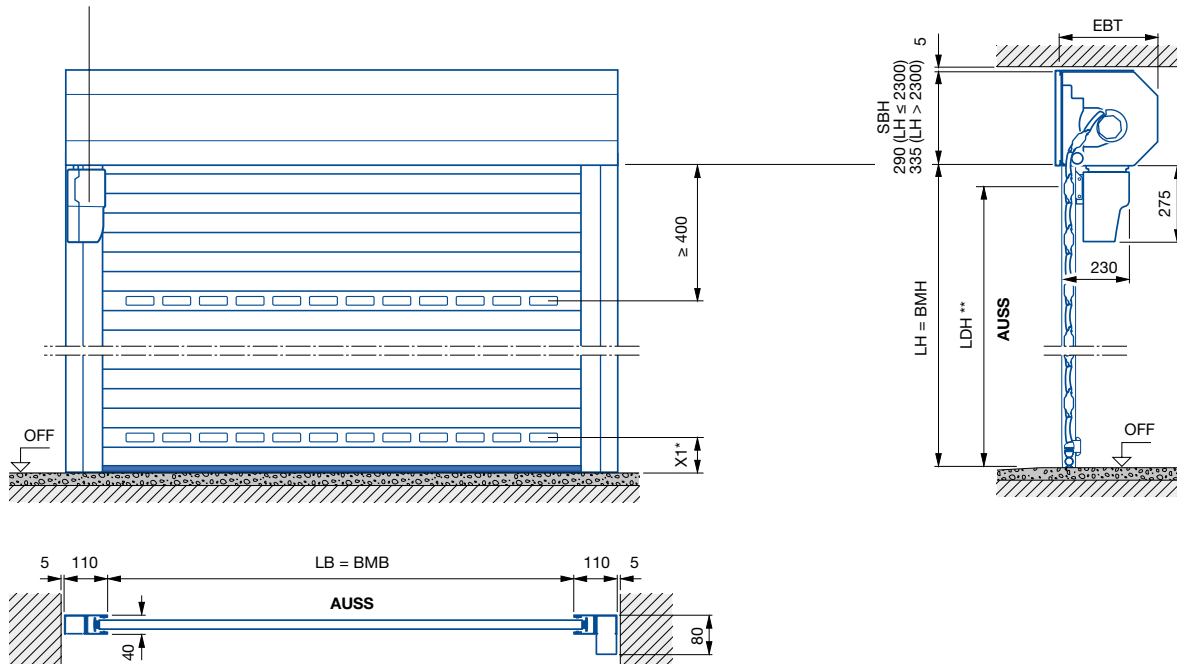

* X1 – min. 150 mm (dimension without chamfered bottom profile)

** See the table “Dimensions” on page 25

An additional fascia panel is required!
See accessories on page 27

Chamfered bottom profile

See page 25

Roller garage door RollMatic 2

Including operator

External roller garage door fitting dimensions



Fitting in front of the opening

Operator as standard on left when viewed from outside. Operator on right optionally available.

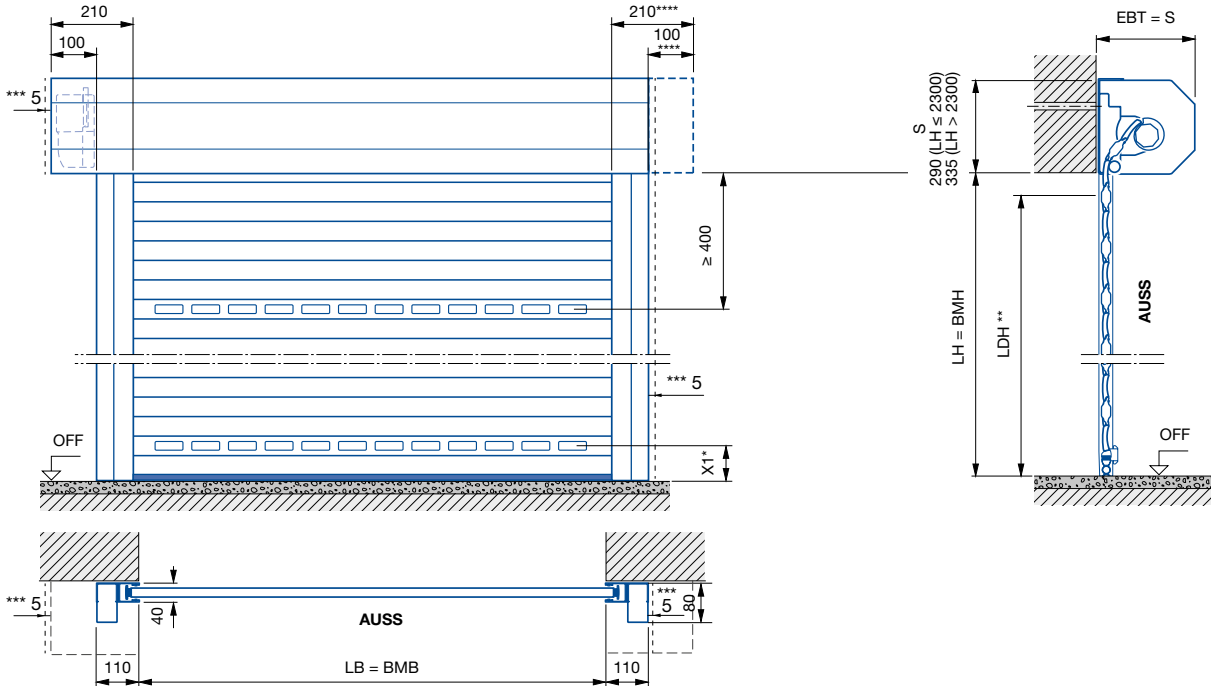

- * X1 – min. 150 mm (dimension without chamfered bottom profile)
- ** See the table "Dimensions"
- *** At least 5 mm distance from fascia panel / side guide
- **** For a visually balanced look the curtain cover can be ordered symmetrically!

Dimensions

	Version with operator RollMatic	Manually operated version (not available for external roller garage doors)
Clear passage height	= Clear height (ordering size height) – 100 mm	= Clear height (ordering size height) – 125 mm
Clear passage width	= Clear width (ordering size width)	= Clear width (ordering size width)

Chamfered bottom profile

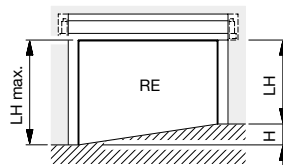
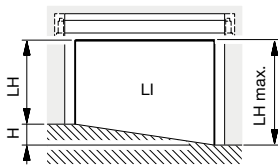

- LH = (Clear height on short side) = ordering size height
Max. LH = 3100 mm
Min. LH = 1600 mm
- H = Height – difference max. 300 mm

Chamfered bottom profile – view of fitting side
Internal roller garage door from inside
External roller garage door from outside

AUSS	Exterior	OFF	Finished floor level
BMB	Ordering size width	RAMB	Overall frame width
BMH	Ordering size height	RAMH	Overall frame height
EBT	Fitting depth	S	Required headroom
LB	Clear width	SBH	Additional fascia panel height
LH	Clear height		
LDB	Clear passage width	min.	At least
LDH	Clear passage height	max.	Maximum

Optional extras

For roller garage door RollMatic 2 including operator



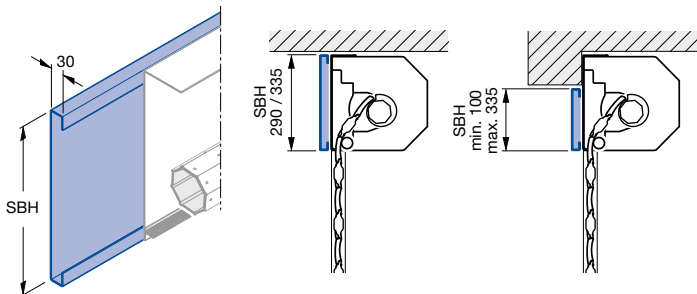

Fitting compensation set		Article no.		£
(to accommodate for unevenness on the building structure when fitting behind / in front of the opening)				
Fitting compensation set LH ≤ 2300		8991235	Per set	64
Fitting compensation set LH > 2300		8991236	Per set	70
Chamfered bottom profile				£
Roller garage door RollMatic with chamfered bottom profile (not available in the surfaces Golden Oak and Rosewood)				
	In black		Per m	475
	In door colour		Per m	475
Symmetrical curtain cover				£
Symmetrical curtain cover for a visually balanced look				Per door No surcharge
Additional fascia panel				£
Reinforcement of the fascia panel				
Note: Required for fitting in the opening!				
	In door colour		Per m	97
▶ State additional fascia panel height (SBH) and width!				



Note:
State on door order, subsequent fitting is not possible.

SBH Fascia panel height
min. At least
max. Maximum

Optional extras		Article no.		£
	Glazing element With clear synthetic pane, window cut-out 112 × 33 mm, black glazing frame on exterior, transparent on interior (maximum 10 sections per door, number of glazing elements depending on the door width)		Per m	42
	Ventilation grilles Black plastic Ventilation cross section: approx. 13 cm ² / grille (maximum of 10 sections per door, number of ventilation grilles depending on the door width)		Per m	42
	Brush seal for fascia panel	LB up to 3000 mm	8991423	Per door 22
		LB from 3000 mm to 5000 mm	8991424	Per door 33
Aluminium cover for side guides (as standard with external roller garage door)				Per m 68
2-coloured roller garage door RollMatic				£
After technical clarification!				
2-coloured roller garage door – frame and door curtain			Per door	166
2-coloured door curtain (The individual section is always only available in a single colour on the interior and exterior)			Per door	461

Optional extras

For roller garage door RollMatic 2 including operator



Accessories for operator RollMatic		Article no.		£
Accessory bag for permanent connection		4510779	Each	8
Motor connection line, 10 m		4510774	Each	40
Acoustic anti-lift kit		4510872	Each	90
Emergency battery HNA 18-4		4510095	Each	270
Emergency release				£
Exterior emergency release for internal roller garage door		436526	Each	135
Exterior emergency release for external roller garage door	Exterior emergency release	436526	Each	135
	Accessory bag for double secured release SE	4510833	Each	9
	Bowden cable, length 1 m, for double secured release SE	437986	Each	18
Note: All 3 articles are required for the external roller garage door!				
Bottom profile with closing edge protection				£
Retrofit kit for bottom profile with closing edge safety device		8992141	Each	492

Fixed element £

Element infill with roller garage door sections in RollMatic look. Position of sections does not match the roller garage door RollMatic. Frame made of aluminium extrusion profile. Coated in colour of the element infill. Decopaint and Decograin colours matching the Decopaint / Decograin surface finish. RAMB max. 6000 mm. Reinforcement profile from RAMB \geq 5001 mm.

	Based on RAL 9016	Per m ²	
	Colour	Per m ²	656
	Decopaint	Per m ²	
	Decograin	Per m ²	

The drawings show a perspective view of the frame with dimensions RAMB (width) and RAMH (height). A side view shows the 'Auss' profile with a 70mm offset. A bottom view shows the 'Auss' profile with 80mm and 70mm offsets.

AUSS Exterior
RAMB Overall frame width
RAMH Overall frame height

Manufacturing dimensions

- without reinforcement profile RAMB \leq 5000 mm = RAMH min. 360 mm
- with reinforcement profile RAMB \geq 5001 mm = RAMH min. 470 mm

Note:

Only one side (width or height) may be > 2500 mm!

Good reasons to try Hörmann garage doors

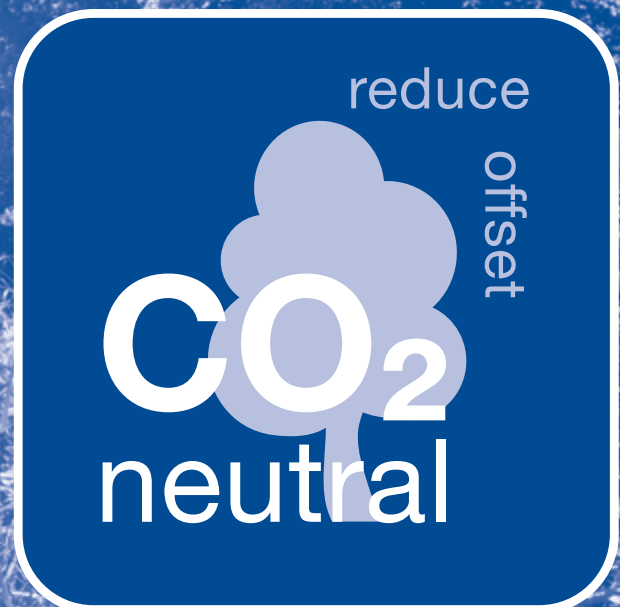

 **ClimatePartner**
certified product
climate-id.com/XNEBKC

 **CO₂**
measure
reduce
contribute

Learn more about our sustainability strategy at
www.hoermann.com/sustainability



We think and act green

Carbon neutral as standard with all sectional doors, up-and-over doors and roller garage doors

HÖRMANN

Good reasons to try Hörmann entrance doors

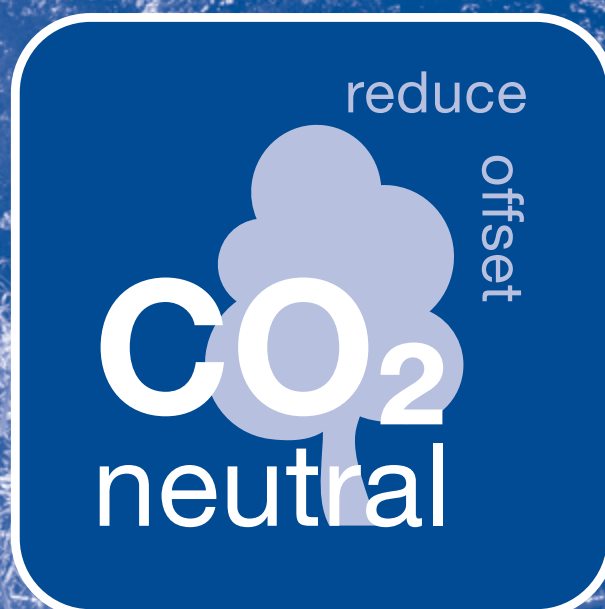

ClimatePartner
certified product
climate-id.com/XNEBK



CO₂
measure
reduce
contribute

Learn more about our sustainability
strategy at
www.hoermann.com/sustainability



We think and act green

**Carbon neutral as standard with
all steel / aluminium entrance doors**

Roller garage door RollMatic T

Including tubular drive

Product description and fitting dimensions



General rules

Roller garage door with tubular drive and emergency crank handle for private use. With integral catch safety device and closing edge safety device as standard. Version as internal or external roller garage door, max. 10 door cycles per day according to warranty conditions.

- Wind load class 3 to LB 3000 mm (FS 75 without wind lock)
- Wind load classes with wind locks (FS 105 from LB 3001 mm):
 - LB 3000 mm to 4000 mm = wind load class 4
 - LB 4000 mm to 4500 mm = wind load class 3
 - LB 4500 mm to 5000 mm = wind load class 2

Frame

- Aluminium extrusion profile side guides with integrated strip brush profile and brush profile. Coating in door curtain colour.
- Lintel cladding made of sheet steel in door curtain colour.
- Curtain cover made of sheet steel, coated in door curtain colour.
- Side cladding of internal roller garage doors made of sheet steel, coated in door curtain colour.
- Side cladding of external roller garage doors made of aluminium, coated in door curtain colour.
- Side guides, lintel and curtain cover coated in basic colour of the timber finish in Decopaint / Decograin version.

Door curtain

Rolled aluminium profile foamed with polyurethane rigid foam with plastic runners, 77 mm section height without ribbing in the profile. Coloured versions with two-layer coil coating with a paint system based on a high-quality polyurethane coated with polyamide.

Note:

All Hörmann roller garage doors correspond to their technical properties and use state-of-the-art paint systems. Pressure marks and abrasive wear are design-related and cannot be avoided. They do not impair the function and durability of the roller garage door.

Surface coating

Version in standard colours

Interior and exterior of door curtain:

- Standard colours based on the RAL colour chart:

RAL 9016 Traffic white	RAL 7016 Anthracite grey
RAL 1015 Light ivory	RAL 7035 Light grey
RAL 3003 Ruby red	RAL 8028 Terra brown
RAL 3004 Purple red	RAL 9001 Cream
RAL 5011 Steel blue	RAL 9005 Jet black
RAL 6005 Moss green	RAL 9006 White aluminium*
RAL 7015 Slate grey	RAL 9007 Grey aluminium*
- Chartwell Green
- Noir 2100 Sablé (Anthracite metallic) – at a surcharge

Note:

Dark colours should not be used for doors that are exposed to the sun.

* IMPORTANT:

Despite the use of state-of-the-art colour coating systems, we cannot rule out colour deviations, specifically in metallic colours such as RAL 9006 or 9007.

Decopaint version with paint in timber design look

Door curtain with paint on the outside and timber design look on the inside
Curtain cover in the basic colour of the Decopaint coating:

- **Golden Oak** – medium brown, yellow-gold surface with vibrant oak character
- **Rosewood** – reddish-brown stripey timber design

Decograin version with plastic film coating with timber design (not available for external roller garage doors)

Door curtain, exterior:

- Coated with UV-resistant synthetic film with timber design with embossed grain for an authentic timber character.
 - **Golden Oak** – medium brown, yellow-gold surface with vibrant oak character
 - **Rosewood** – reddish-brown stripey timber design

Door curtain, interior:

- Terra brown coating based on RAL 8028

Operator data and control electronics

- Tubular drive with emergency hand chain drive and crank handle drive for operation in case of power failure
 - Tubular drive technology with mechanically adjustable end-of-travel position (standard)
 - Tubular drives with electronically adjustable end-of-travel positions (optional)
- Door cycles (Open / Close)
 - max. 10 per day / max. 3 per hour
 - On-time of tubular drive max. 4 min. per hour
- Operator possible with impulse operation on left or right side (querying of the door position not possible)
- Control housing with integrated LED light
- Operation with 2 push buttons on the control housing
- Operation via hand transmitter 868 MHz BiSecur with 2 x hand transmitter HSE 4 BS (standard)
- Optical closing edge safety device installed at the factory in the bottom profile ensures safety as per DIN EN 13241-1
 - Closing edge safety device with spiral cable (standard)
 - Radio closing edge safety device (optional, receiver integrated in control housing)
- Adjustable reversing procedure
- Adjustable pre-warning phase
- Connection of external illumination possible
- Adjustable automatic timer
- Connecting option for one-way photocell EL 31

Standard equipment

- Door including tubular drive, emergency hand chain drive and complete curtain cover as standard.
- Control with 2 control buttons in the cover and integrated radio receiver 868 MHz rolling code
- 2 x HSE 4 BS BiSecur 868 MHz hand transmitter
- Connecting lead with plug
- Optical closing edge safety device (with spiral cable) with photocell in bottom profile
- External roller garage door with emergency release lock

Delivery

2-part packaging incl. operator

Size range

Clear height (LH) = ordering size height (BWH)	3100	A	–
	2500		C
	2301	B	
	2300		
1200			
		1000 ... 3000	3001 ... 5000
		Clear width (LB) = ordering size width (BMB)	

- A** EBT/S 335, LB ≤ 3000 = FS 75, shaft 70 mm, without wind lock
- B** EBT/S 290, LB ≤ 3000 = FS 75, shaft 70 mm, without wind lock
- C** EBT/S 335, LB > 3000 = FS 105, shaft 80 mm, with wind lock
- D** EBT/S 290, LB > 3000 = FS 105, shaft 80 mm, with wind lock

Roller garage door RollMatic T

Including tubular drive

Product description and fitting dimensions



Internal roller garage door – fitting behind the opening

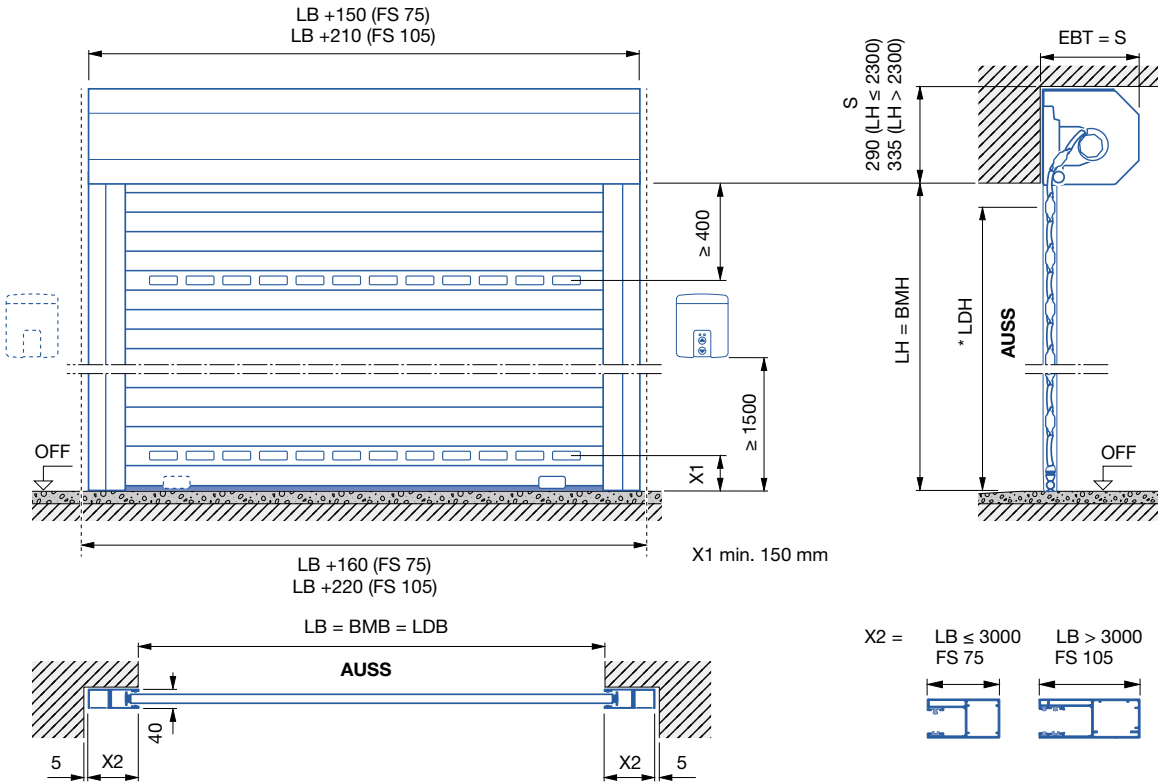

Internal roller garage door – fitting in the opening

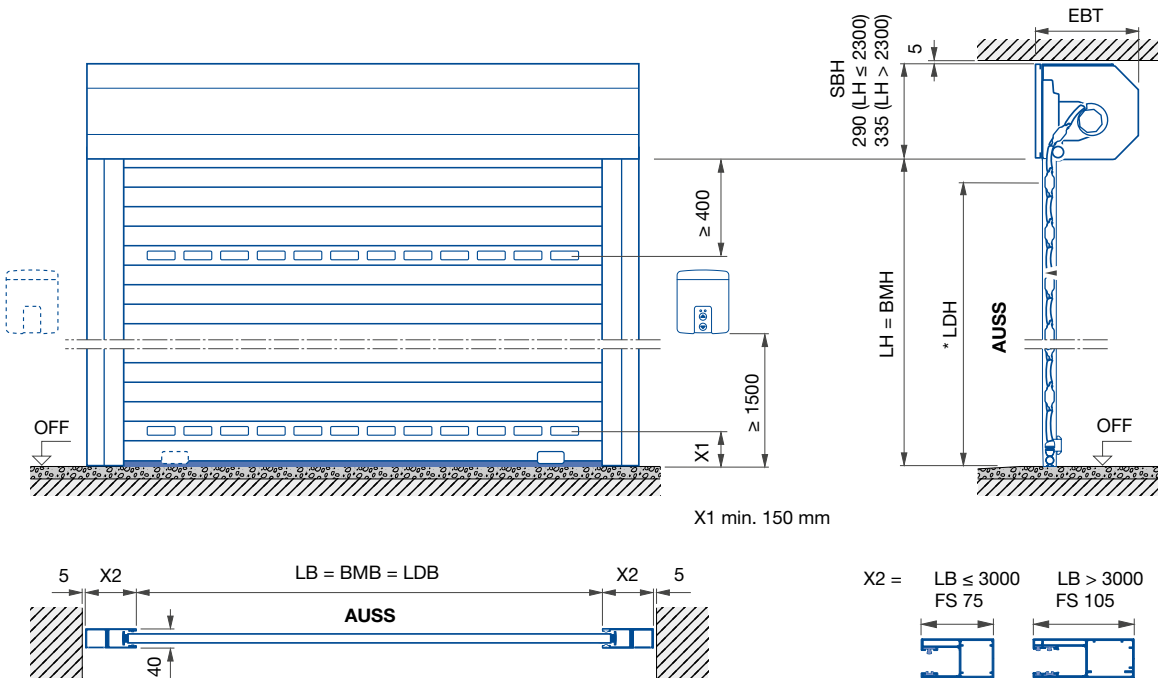

An additional fascia panel is required!

AR	External roller garage door	FS	Side guide	LH	Clear height	max.	Maximum
AUSS	Exterior	IR	Internal roller garage door	S	Required headroom	OFF	Finished floor level
BMB	Ordering size width	LB	Clear width	SBB	Additional fascia panel width	* LDH	= LH - 70 (FS 75)
BMH	Ordering size height	LDB	Clear passage width	SBH	Additional fascia panel height		= LH - 110 (FS 105)
EBT	Fitting depth	LDH	Clear passage height	min.	Minimum		

Roller garage door RollMatic T

Including tubular drive

Product description and fitting dimensions



External roller garage door – fitting in front of the opening

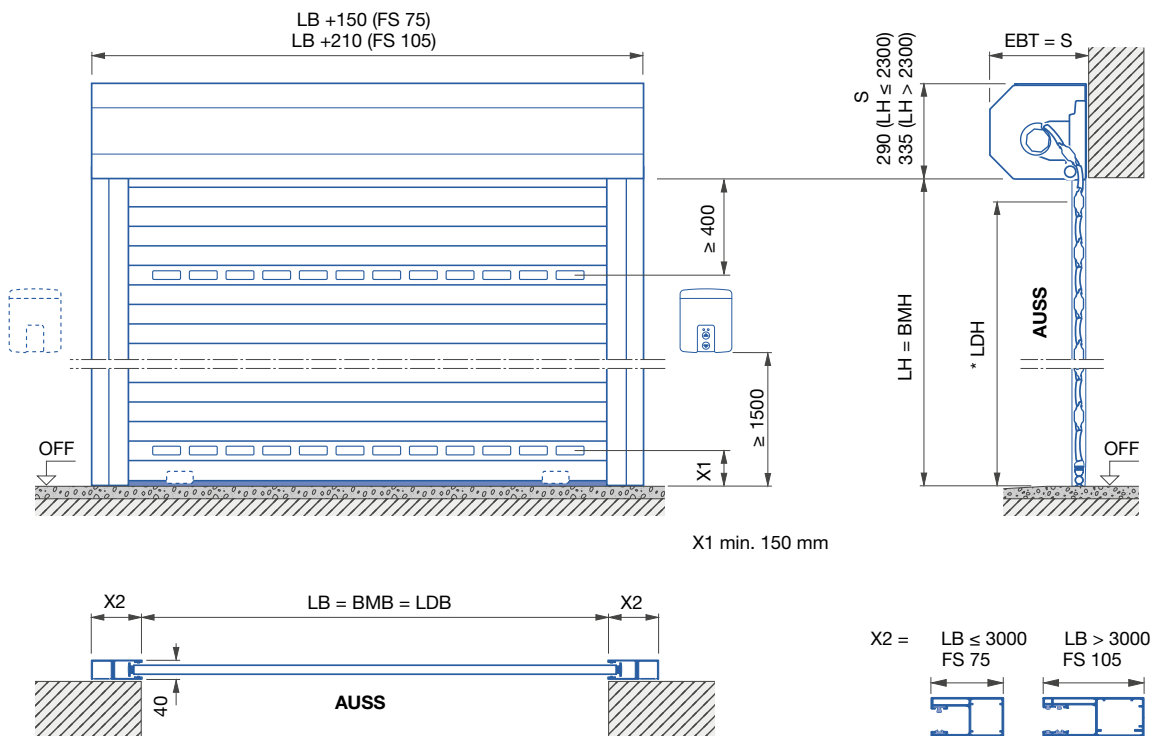

Glazing and/or ventilation grille arrangement (optional)

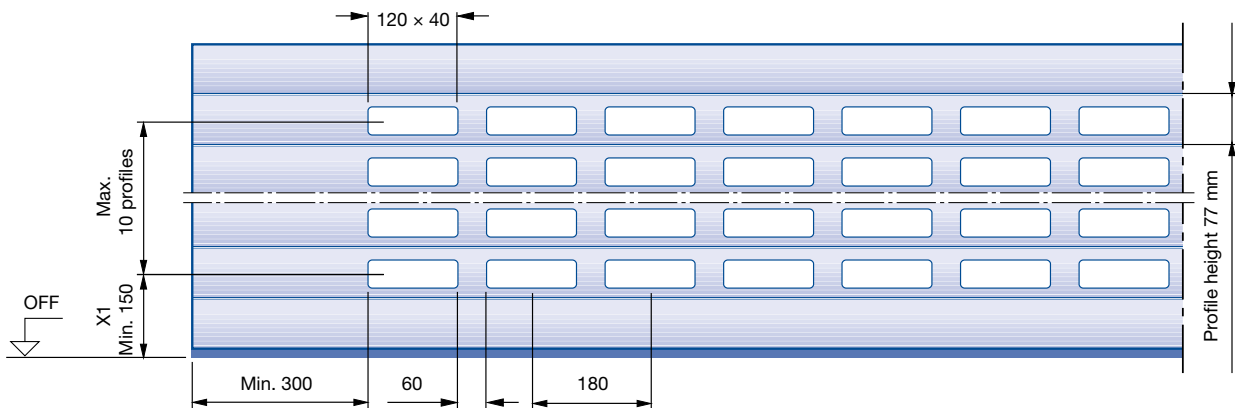

Note:

- Glazing/ventilation arrangement is only possible starting at the 2nd section from the bottom.
- For technical reasons, the glazing/ventilation arrangement in the curtain is only possible starting at the 8th visible section from the top.

AR	External roller garage door	FS	Side guide	LH	Clear height	max.	Maximum
AUSS	Exterior	IR	Internal roller garage door	S	Required headroom	OFF	Finished floor level
BMB	Ordering size width	LB	Clear width	SBB	Additional fascia panel width		
BMH	Ordering size height	LDB	Clear passage width	SBH	Additional fascia panel height	* LDH	= LH - 70 (FS 75) = LH - 110 (FS 105)
EBT	Fitting depth	LDH	Clear passage height	min.	Minimum		

Roller garage door RollMatic T

Including tubular drive

Size range and prices



For a product description, see from page 31



Exterior
Standard colours

Prices for internal roller garage door RollMatic T – version with tubular drive

Clear height (LH) = ordering size height (BMH)	3100	2322	2406	2470	2546	2546	2630	2708	2790	2894	3411	3487	3569	3650						
	3000	2322	2406	2470	2546	2546	2630	2708	2790	2894	3411	3487	3569	3650						
	2875	2322	2406	2470	2546	2546	2630	2708	2790	2894	3411	3487	3569	3650	3746					
	2750	2289	2363	2420	2496	2496	2572	2647	2720	2816	3224	3299	3373	3448	3536	3601				
	2675	2289	2363	2420	2496	2496	2572	2647	2720	2816	3224	3299	3373	3448	3536	3601				
	2625	2289	2363	2420	2496	2496	2572	2647	2720	2816	3224	3299	3373	3448	3536	3601	3692			
	2500	2250	2318	2372	2440	2440	2505	2579	2647	2735	3137	3207	3274	3346	3511	3594	3665	3730		
	2375	2240	2307	2359	2423	2423	2496	2562	2630	2716	3115	3180	3247	3314	3481	3561	3627	3698		
	2250	2211	2277	2322	2384	2384	2447	2514	2575	2656	3051	3115	3177	3241	3302	3380	3444	3505		
	2125	2195	2254	2300	2359	2359	2417	2480	2539	2617	3007	3068	3126	3189	3247	3322	3380	3444		
	2000	2184	2244	2289	2348	2348	2406	2462	2520	2602	2987	3043	3104	3163	3221	3296	3351	3411		
	1750	2159	2211	2247	2303	2303	2359	2414	2470	2542	2920	2975	3027	3080	3137	3204	3257	3314		
	1500	2123	2174	2200	2250	2250	2300	2348	2396	2466	2833	2883	2933	2977	3027	3090	3137	3189		
	1200																			
			1000	1250	1500	1750	1900	2000	2250	2500	2750	3000	3250	3500	3750	4000	4250	4500	4750	5000
			Clear width (LB) = ordering size width (BMB)																	

Only available in the priced size range listed! (Minimum production dimensions BR 1000 x 1200 mm)

Surfaces		£
Noir 2100 Sablé (Anthracite metallic)		37
Decopaint	Painted in timber design look (Golden Oak or Rosewood) on inside and outside	£ per m ² 37
Decograin	Plastic film coating in timber design look (Golden Oak or Rosewood) on outside	£ per m ² 69
Note: External roller garage door not available with Decograin surface finish!		

Roller garage door RollMatic T

Including tubular drive

Surcharges for optional extras



External roller garage door				£
Version as external roller garage door (fitting in front of the opening)			Per door	66
Radio				£
Radio receiver 868 MHz BiSecur with 2 × hand transmitter HSE 4 BS			Per door	Standard
Operator				£
Operator with mechanically adjustable end-of-travel position			Per door	Standard
Operator with electronically adjustable end-of-travel positions			Per door	431
Closing edge safety device				£
Closing edge safety device with spiral cable			Per door	Standard
Closing edge safety device with radio (receiver integrated in control housing)			Per door	234
Fitting compensation set				£
(to accommodate for unevenness on the building structure when fitting behind/in front of the opening)				
		Article no.		
Fitting compensation set LH ≤ 2300	(FS 75)	8991193	Per set	64
	(FS 105)	8991235	Per set	64
Fitting compensation set LH > 2300	(FS 75)	8991194	Per set	70
	(FS 105)	8991236	Per set	70
DuraBelt – winding unit				£
	LB 1000 – 1600 mm	2 winding units	Surcharge per door	90
	LB 1601 – 3000 mm	3 winding units	Surcharge per door	134
	LB 3001 – 5000 mm	5 winding units	Surcharge per door	223
We recommend the use of the DuraBelt winding unit to reduce design-related abrasion on the door curtain to a minimum				
	Retrofit kit	2 winding units	8995301	Per door
	Up to LH 2300 mm	3 winding units	8995302	Per door
	Retrofit kit	2 winding units	8995303	Per door
	From LH 2301 mm	3 winding units	8995304	Per door
Additional fascia panel				£
Reinforcement of the fascia panel				
Notes:		In door colour	Per m	97
<ul style="list-style-type: none"> • Required for fitting in the opening! • State on door order, subsequent fitting is not possible! 				
▶ State additional fascia panel height (SBH) and width!				
AR	External roller garage door	SBH	Additional fascia panel width	
IR	Internal roller garage door	SBH	Additional fascia panel height	
LB	Clear width	min.	Minimum	
Exterior emergency release			Each	275
Internal roller garage door				
Note:				
<ul style="list-style-type: none"> • Min. LH 1700 mm • Wall thickness ≤ 500 mm 				
Optional extras				£
		Article no.		
	Glazing element With clear synthetic pane, window cut-out 112 × 33 mm, black glazing frame on exterior, transparent on interior (maximum 10 sections per door, number of glazing elements depending on the door width)		Per m	42
	Ventilation grilles Black plastic Ventilation cross section: approx. 13 cm ² /grille (maximum of 10 sections per door, number of ventilation grilles depending on the door width)		Per m	42
Brush seal for fascia panel		LB up to 3000 mm	8991423	Per door
		LB from 3000 mm to 5000 mm	8991424	Per door

Garage horizontal door RollMatic OD

Including side operator ProMatic

Product description



General rules

Spring-compensated garage horizontal door for private use. As standard, when the Hörmann operator ProMatic is used – max. 10 door cycles per day according to the warranty conditions.

Frame

- Vertical side guides made of aluminium extrusion profiles with integrated brush seal, coated in door curtain colour. Horizontal guide rails and fascia panel made of aluminium extrusion profile, coated in the door curtain colour Decopaint / Decograin version – colours matching the Decopaint / Decograin surface finish.

Door curtain

- Rolled aluminium profile foamed with polyurethane rigid foam with rollers, profile height 77 mm. Coloured versions with two-layer coil coating with a paint system based on a high-quality polyurethane coated with polyamide.
- Bottom profile with bottom seal.

Note:

All Hörmann roller garage doors correspond to their technical properties and use state-of-the-art paint systems. Pressure marks and abrasive wear are design-related and cannot be avoided. They do not impair the function and durability of the roller garage door.

Surface coating

Version in standard colours

Interior and exterior of door curtain:

- Standard colours based on the RAL colour chart:

RAL 9016 Traffic white	RAL 7016 Anthracite grey
RAL 1015 Light ivory	RAL 7035 Light grey
RAL 3003 Ruby red	RAL 8028 Terra brown
RAL 3004 Purple red	RAL 9001 Cream
RAL 5011 Steel blue	RAL 9005 Jet black
RAL 6005 Moss green	RAL 9006 White aluminium*
RAL 7015 Slate grey	RAL 9007 Grey aluminium*
- Chartwell Green
- Noir 2100 Sablé (Anthracite metallic) – at a surcharge

Note:

Dark colours should not be used for doors that are exposed to the sun.

* IMPORTANT:

Despite the use of state-of-the-art colour coating systems, we cannot rule out colour deviations, specifically in metallic colours such as RAL 9006 or 9007.

Decopaint version with paint in timber design look

Interior and exterior of door curtain:

- Golden Oak** – medium brown, yellow-gold surface with vibrant oak character
- Rosewood** – reddish-brown stripey timber design

Decograin version with plastic film coating with timber design

Door curtain, exterior:

- Coated with UV-resistant synthetic film with timber design with embossed grain for an authentic timber character.
 - Golden Oak** – medium brown, yellow-gold surface with vibrant oak character
 - Rosewood** – reddish-brown stripey timber design

Door curtain, interior:

- Terra brown coating based on RAL 8028

Counterbalance

Tension spring system with lateral integral multiple tension spring assemblies. Transmission of forces via a cable, including cable guide and safety catch.

Closing devices

Locking with garage door operator.

Delivery

1 unit including operator

Glazing and / or ventilation grille arrangement (optional equipment)

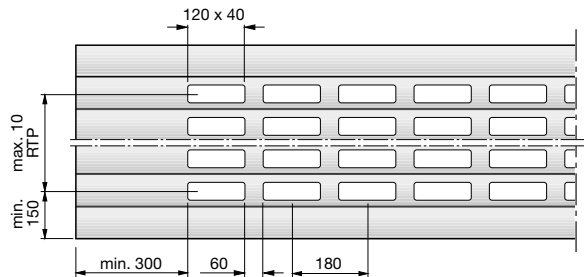

Note:

Glazing / ventilation grille arrangement is only possible starting at the 2nd section from the bottom.

Operator (side operator)

- As standard with garage door operator ProMatic
- Optionally with garage door operator SupraMatic E for a surcharge.
- Operator possible on the left or right, please state on order!

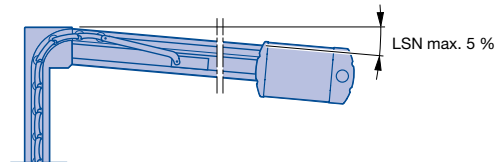

AUSS	Exterior
BMB	Ordering size width
BMH	Ordering size height
LE	Distance back with operator
LB	Clear width
LH	Clear height
LDB	Clear passage width
LDH	Clear passage height
LMB	Structural opening width
LSN	Track slope
max.	Maximum
min.	At least
OFF	Finished floor level
RAMB	Overall frame width
RAMH	Overall frame height
S	Lintel

Garage horizontal door RollMatic OD

Including side operator ProMatic

Fitting dimensions



Fitting behind the opening

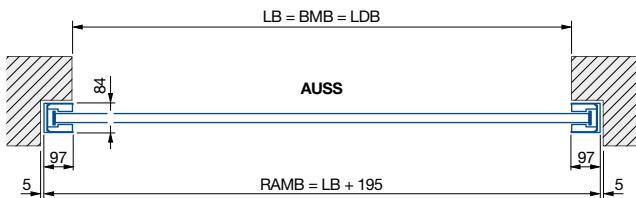
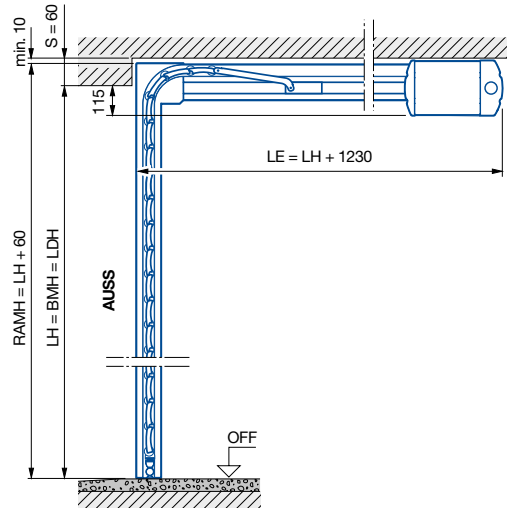
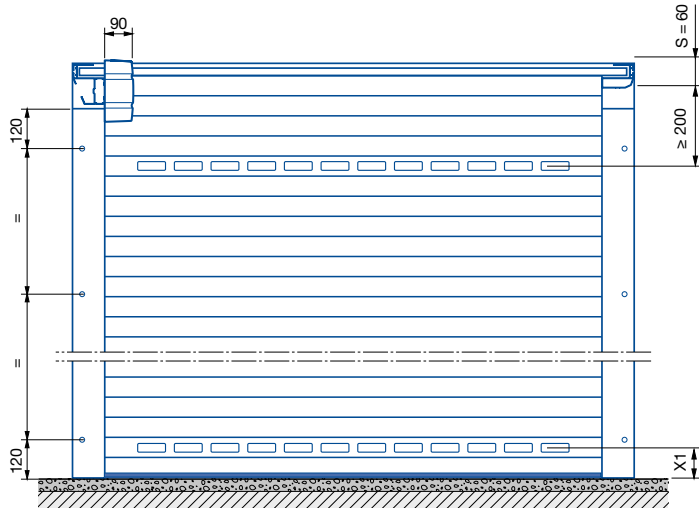

X1 min. 150

Fitting in the opening

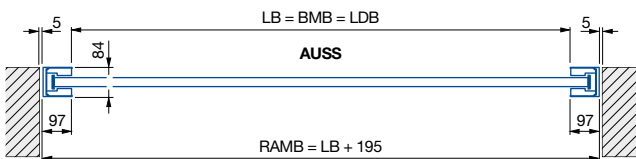
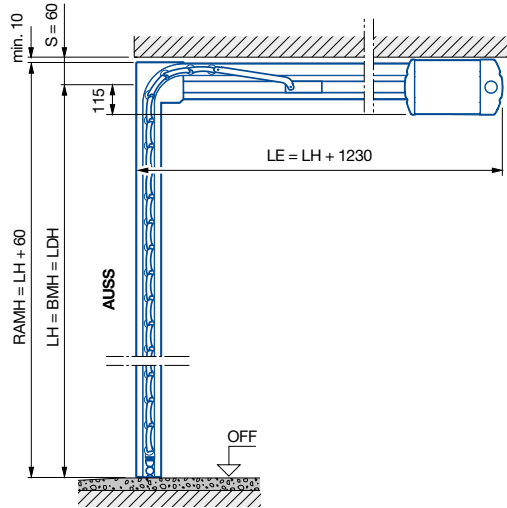
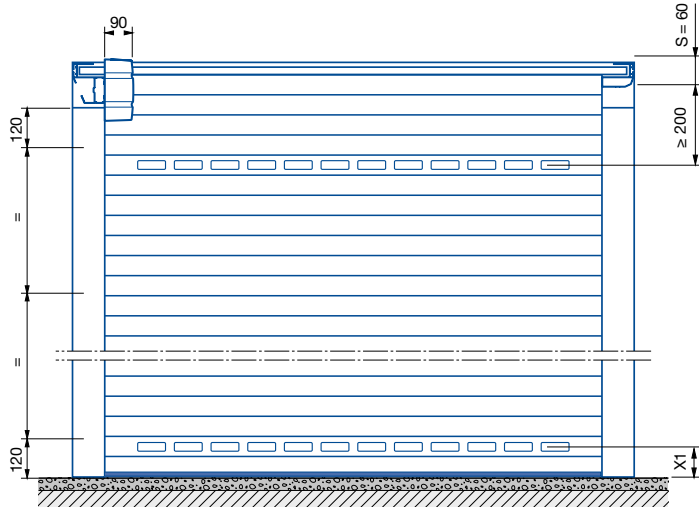

X1 min. 150

Garage horizontal door RollMatic OD

Including side operator ProMatic

Fitting dimensions



Flush fitting in the opening with panel 95

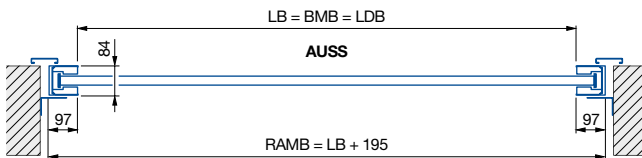
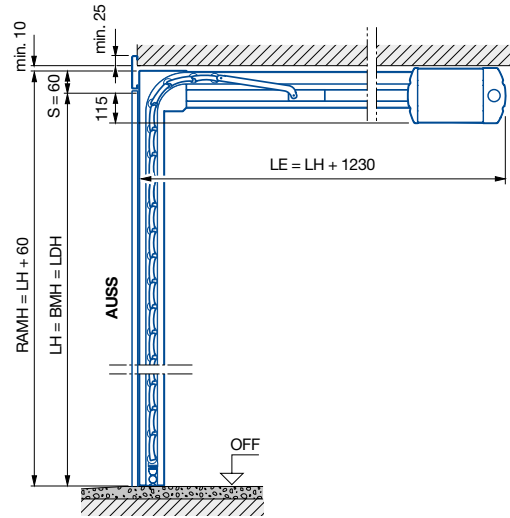
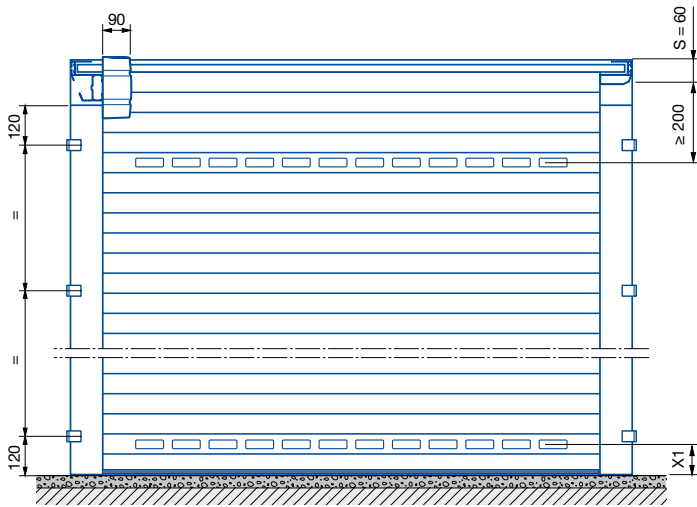

LB max. 3150
LH max. 2700
X1 min. 150

AUSS	Exterior
BMB	Ordering size width
BMH	Ordering size height
LE	Distance back with operator
LB	Clear width
LH	Clear height
LDB	Clear passage width
LDH	Clear passage height
LMB	Structural opening width
LSN	Track slope
max.	Maximum
min.	At least
OFF	Finished floor level
RAMB	Overall frame width
RAMH	Overall frame height
S	Lintel

Garage horizontal door RollMatic OD

Including side operator ProMatic

Size range and prices



For a product description, see from page 36



Exterior
White or Colour

(same price)

Prices for garage horizontal doors RollMatic OD

Clear height (LH) = ordering size height (BMH)	3000			2769	2838	2914	2978	3052	3116	3191
	2875			2718	2780	2840	2914	2984	3051	3111
	2750			2668	2720	2782	2853	2918	2980	3039
	2625			2610	2671	2719	2788	2855	2913	2966
	2500	2308	2304	2589	2642	2702	2767	2835	2890	2950
	2375	2249	2279	2442	2491	2553	2609	2667	2714	2769
	2250	2195	2248	2307	2355	2408	2466	2516	2566	2620
	2125	2156	2197	2249	2299	2349	2403	2451	2493	2550
	2000	2112	2150	2194	2240	2287	2338	2385	2430	2479
	1875	2066	2126	2145	2196	2248	2291	2342	2393	2442
1700										
	1250	1500	1750	2000	2250	2500	2750	3000	3250	3500

Only available in the priced size range listed! (Minimum production dimensions BR 1250 x 1700 mm)

Surfaces		£
Noir 2100 Sablé (Anthracite metallic)		£ per m ² 37
Decopaint	Painted in timber design look (Golden Oak or Rosewood) on inside and outside	£ per m ² 37
Decograin	Plastic film coating in timber design look (Golden Oak or Rosewood) on outside	£ per m ² 69
Note: External roller garage door not available with Decograin surface finish!		

SupraMatic E, series 4 £



Optionally with garage door operator SupraMatic E, series 4 Surcharge **181**
2 x 4-button hand transmitter HSE 4 BS, textured surface (black) with chrome caps

ProMatic Akku, series 4 Article no. £

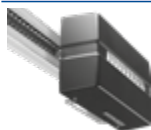

Optionally with garage door operator ProMatic Akku, series 4 Surcharge **430**
4-button hand transmitter HSE 4 BS, textured surface with plastic caps (black)
For a product description, see door operators section in the 01-24 A

Special accessories		£
Replacement battery WA 24 (For a product description and possible number of door cycles, see door operators section in the 01-24 A)	438703 Each	378
Solar module SM 1-2 (For a product description, see door operators section in the 01-24 A)	4511942 Each	545



2-coloured garage horizontal door RollMatic OD See page 40

Optional extras for garage horizontal door RollMatic OD See door operators section in the 01-24 A Dealer Price List

Optional extras

For garage horizontal door RollMatic OD including side operator ProMatic



Optional extras		£
	Glazing element With clear synthetic pane, window cut-out 112 × 33 mm, black glazing frame on exterior, transparent on interior (maximum 10 sections per door, number of glazing elements depending on the door width)	Per m 42
	Ventilation grilles Black plastic Ventilation cross section: approx. 13 cm ² /grille (maximum of 10 sections per door, number of ventilation grilles depending on the door width)	Per m 42

2-coloured garage horizontal door RollMatic OD		£
After technical clarification!		
2-coloured roller garage door – frame and door curtain	Per door	166
2-coloured door curtain (The individual section is always only available in a single colour on the interior and exterior)	Per door	461

Retrofit fascia panels for flush fitting		£
Set: fascia frame OD		
<ul style="list-style-type: none"> As cover for lintel and frame with flush-fitting installation and for renovations For use with doors up to LB max. 3150 mm and LH max. 2700 mm 		
Consisting of:	<ul style="list-style-type: none"> 2 fascias, width 95 mm, length 2800 mm each 1 fascia, width 95 mm, length 3200 mm including additional fixing material for panel and door 2 plastic panel shoes (black) 	

Note:
The vertical tracks and the fascia panel are pre-drilled at the factory if this fitting is selected.

Surface finish		£
White, based on RAL 9016 or Color	Per set	328

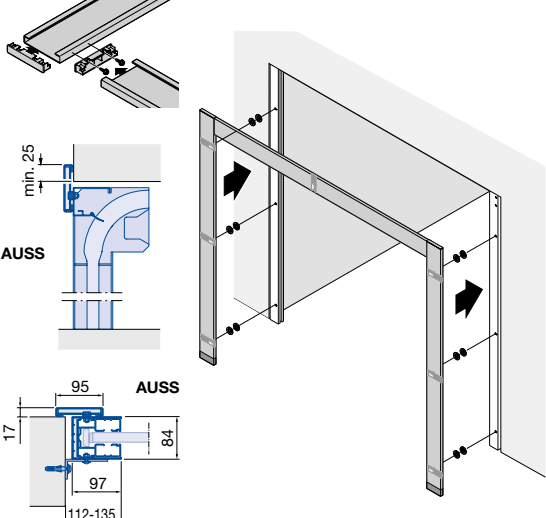

AUSS Exterior
min. At least

Emergency release NET 4 (required if there is no second entrance)	See the "Door operators" section in 01-24 A Dealer Price List
Accessories for operator ProMatic / SupraMatic E	See the "Door operators" section in 01-24 A Dealer Price List

Cleaning and care	Article no.	£
Cleaning cloth	Cleaning cloth (size 40 × 50 cm) Ready-to-use microfibre cloth for matt, glossy, film-coated and printed surfaces.	4018988 Each 10
Cleaning and maintenance set	Contents 1 × cleaner, 1 × cleaning sponge, 1 × 2-in-1 polish, 1 × polishing sponge, 2 × microfibre cloth, 1 × oil	4020356 Per set 72

NT 60 side doors

For roller garage door RollMatic / garage horizontal door RollMatic OD
Single-leaf side doors with corner frame made of aluminium profiles



Product description

Subject to changes

General rules

Door set for private use

Notes:

- Doors cannot be driven!
- For internal fitting please state when ordering, subsequent change is not possible.

Door leaf and frame

Door leaf frame and frame made of aluminium extrusion profiles (normal profile, without thermal break), depth 60 mm, 3-sided double door seal, double lip seal in the threshold area.

Door infill: roller garage door sections in RollMatic look.

Rolled aluminium profile foamed with polyurethane rigid foam, profile height 77 mm. Coloured versions with two-layer coil coating with a paint system based on a high-quality polyurethane coated with polyamide.

Position of sections does not match the roller garage door RollMatic. Glazing and ventilation grilles arranged as in the roller garage door RollMatic.

Frame including plug holes under the cover strip.

Thermal insulation value*:

- Fitted side door NT 60 $U = 5.6 \text{ W}/(\text{m}^2 \cdot \text{K})$
- * In relation to door size 1250 x 2200 mm

Version – wide leaf frame

Lever height: 1050 mm

Opening inwards

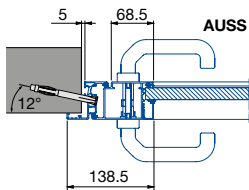

Opening outwards

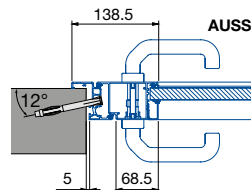

Fittings and closing devices

- Lever handle set with oval rose escutcheons in black plastic, prepared for profile cylinder
- Lock with profile cylinder, keys to differ or keys to pass
- Hinges optionally in black, white or aluminium natural finish

The handle set version can be selected for a surcharge.

Surface coating

Color based on RAL

- Door infill in Color on interior and exterior
- Standard colours based on the RAL colour chart:

RAL 9016	Traffic white	RAL 7016	Anthracite grey
RAL 1015	Light ivory	RAL 7035	Light grey
RAL 3003	Ruby red	RAL 8028	Terra brown
RAL 3004	Purple red	RAL 9001	Cream
RAL 5011	Steel blue	RAL 9005	Jet black
RAL 6005	Moss green	RAL 9006	White aluminium*
RAL 7015	Slate grey	RAL 9007	Grey aluminium*
- Chartwell Green
- Noir 2100 Sablé (Anthracite metallic) – at a surcharge

* IMPORTANT:

Despite the use of state-of-the-art colour coating systems, we cannot rule out colour deviations, specifically in metallic colours such as RAL 9006 or 9007.

Decopaint paint

Decopaint version with paint on the outside and timber design look on the inside

- **Golden Oak** – medium brown, yellow-gold surface with vibrant oak character
- **Rosewood** – reddish-brown stripey timber design

Decograin plastic film coating

Decograin version with plastic film coating with timber design

- **Exterior:** Coated with UV-resistant timber design plastic film with embossed timber structure for an authentic timber character.
 - **Golden Oak** – medium brown, yellow-gold surface with vibrant oak character
 - **Rosewood** – reddish-brown stripey timber design
- **Interior:** coating in RAL 8028 Terra brown

Notes on surface coatings

Deviations in colour are to be expected due to the use of different base materials, such as aluminium and steel, and textures, as well as due to varying production processes and locations.

Despite the use of state-of-the-art colour coating systems, colour deviations cannot be ruled out, specifically in metallic colours such as RAL 9006.

Glazing / ventilation grille

- Glazing / ventilation grille optional
- Not possible in the bottom section and in the lock area (13th and 14th section from the bottom)

NT 60 side doors

For roller garage door RollMatic / garage horizontal door RollMatic OD
Single-leaf side doors with corner frame made of aluminium profiles



Product description

Subject to changes

Fitting dimensions

Internal fitting (opening inwards)

Matching
Internal roller garage
doors RollMatic
Garage horizontal doors
RollMatic OD

Matching
External roller garage
doors RollMatic

External fitting (opening outwards)

Matching
Internal roller garage
doors RollMatic
Garage horizontal doors
RollMatic OD

Matching
External roller garage
doors RollMatic

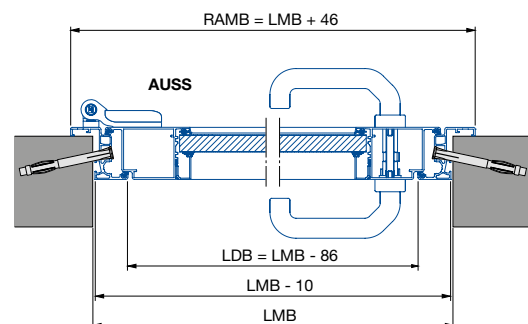
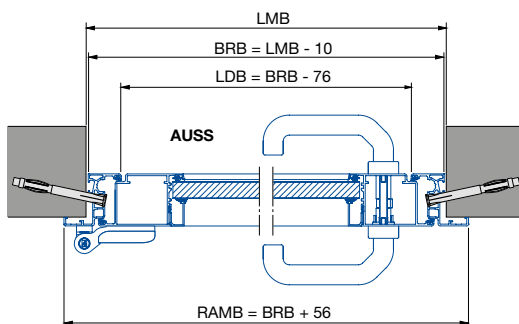
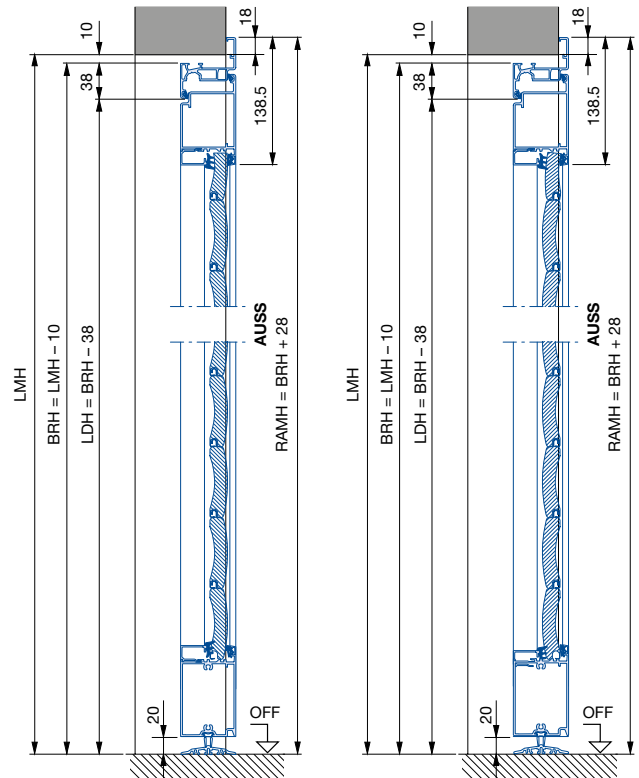
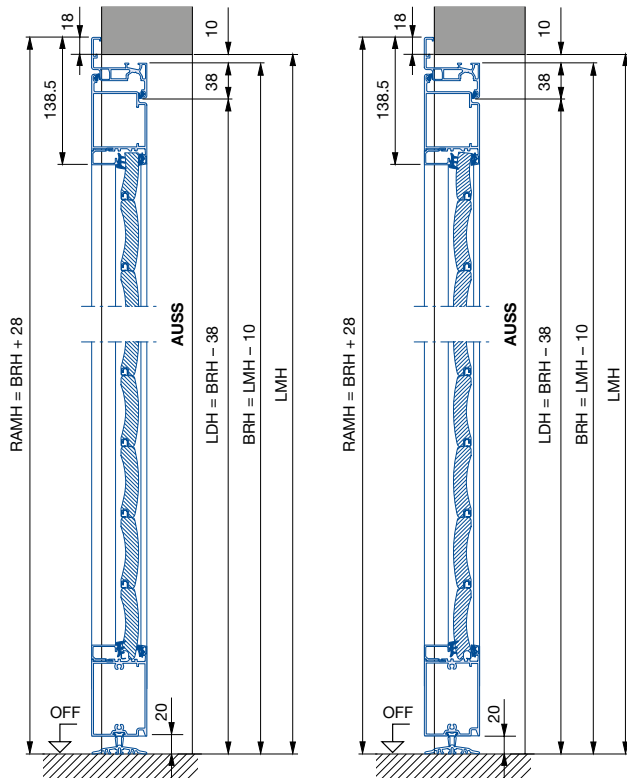

- AUSS** Exterior
- BRB** Nominal width
- BRH** Nominal height
- INNE** Interior
- LDB** Clear passage width
- LDH** Clear passage height
- LI** Left
- LMB** Structural opening width (ordering size)
- LMH** Structural opening height (ordering size)
- RAMB** Overall frame width
- RAMH** Overall frame height
- RE** Right
- OFF** Finished floor level

NT 60 side doors

For roller garage door RollMatic / garage horizontal door RollMatic OD
Single-leaf side doors with block frame made of aluminium profiles



Product description

Subject to changes

General rules

Door set for private use

Notes:

- Doors cannot be driven!
- For internal fitting please state when ordering, subsequent change is not possible.

Door leaf and frame

Door leaf frame and frame made of aluminium extrusion profiles (normal profile, without thermal break), depth 60 mm, 3-sided double door seal, double lip seal in the threshold area.

Door infill: roller garage door sections in RollMatic look. Position of sections does not match the roller garage door RollMatic. Glazing and ventilation grilles arranged as in the roller garage door RollMatic.

Thermal insulation value*:

- Fitted side door NT 60 $U = 5.6 \text{ W}/(\text{m}^2\cdot\text{K})$
- * In relation to door size 1250 x 2200 mm

Version – wide leaf frame

Lever height: 1050 mm

Opening inwards

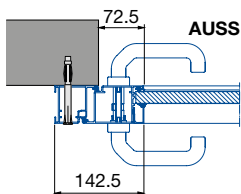

Opening inwards or outwards

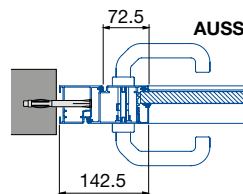

Fittings and closing devices

- Lever handle set with oval rose escutcheons in black plastic, prepared for profile cylinder
- Lock with profile cylinder, keys to differ or keys to pass
- Hinges optionally in black, white or aluminium natural finish

The handle set version can be selected for a surcharge.

Surface coating

Color based on RAL

- Door infill in Colour on interior and exterior
- Standard colours based on the RAL colour chart:

RAL 9016	Traffic white	RAL 7016	Anthracite grey
RAL 1015	Light ivory	RAL 7035	Light grey
RAL 3003	Ruby red	RAL 8028	Terra brown
RAL 3004	Purple red	RAL 9001	Cream
RAL 5011	Steel blue	RAL 9005	Jet black
RAL 6005	Moss green	RAL 9006	White aluminium*
RAL 7015	Slate grey	RAL 9007	Grey aluminium*
- Chartwell Green
- Noir 2100 Sablé (Anthracite metallic) – at a surcharge

* IMPORTANT:

Despite the use of state-of-the-art colour coating systems, we cannot rule out colour deviations, specifically in metallic colours such as RAL 9006 or 9007.

Decopaint paint

Decopaint version with paint on the outside and timber design look on the inside

- **Golden Oak** – medium brown, yellow-gold surface with vibrant oak character
- **Rosewood** – reddish-brown stripey timber design

Decograin plastic film coating

Decograin version with plastic film coating with timber design

- **Exterior:** Coated with UV-resistant timber design plastic film with embossed timber structure for an authentic timber character.
 - **Golden Oak** – medium brown, yellow-gold surface with vibrant oak character
 - **Rosewood** – reddish-brown stripey timber design
- **Interior:** coating in RAL 8028 Terra brown

Notes on surface coatings

Deviations in colour are to be expected due to the use of different base materials, such as aluminium and steel, and textures, as well as due to varying production processes and locations.

Despite the use of state-of-the-art colour coating systems, colour deviations cannot be ruled out, specifically in metallic colours such as RAL 9006.

Glazing / ventilation grille

- Glazing / ventilation grille optional
- Not possible in the bottom section and in the lock area (13th and 14th section from the bottom)

NT 60 side doors

For roller garage door RollMatic / garage horizontal door RollMatic OD
Single-leaf side doors with block frame made of aluminium profiles



Product description

Subject to changes

Fitting dimensions

Fitting behind the opening (opening inwards)

Matching
Internal roller garage
doors RollMatic
Garage horizontal doors
RollMatic OD

Matching
External roller garage
doors RollMatic

Fitting in the opening (opening inwards)

Matching
Internal roller garage
doors RollMatic
Garage horizontal doors
RollMatic OD

Matching
External roller garage
doors RollMatic

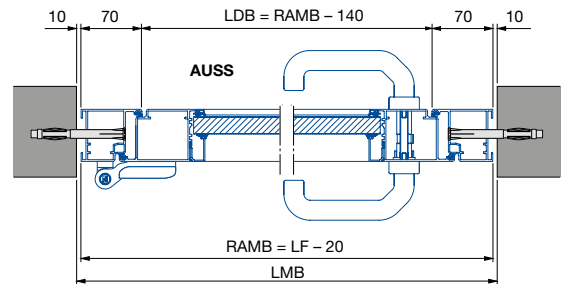
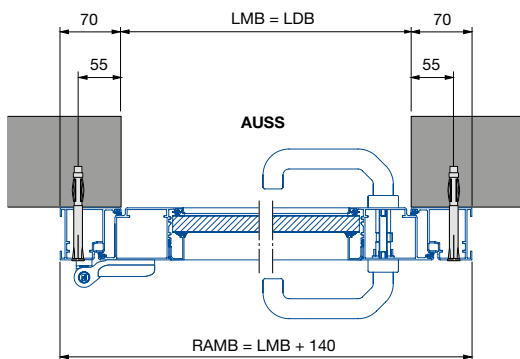
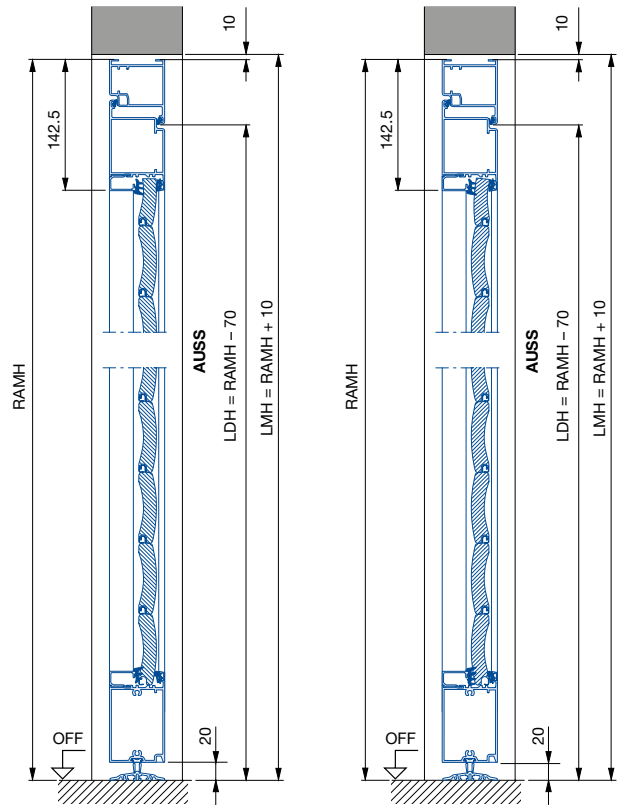
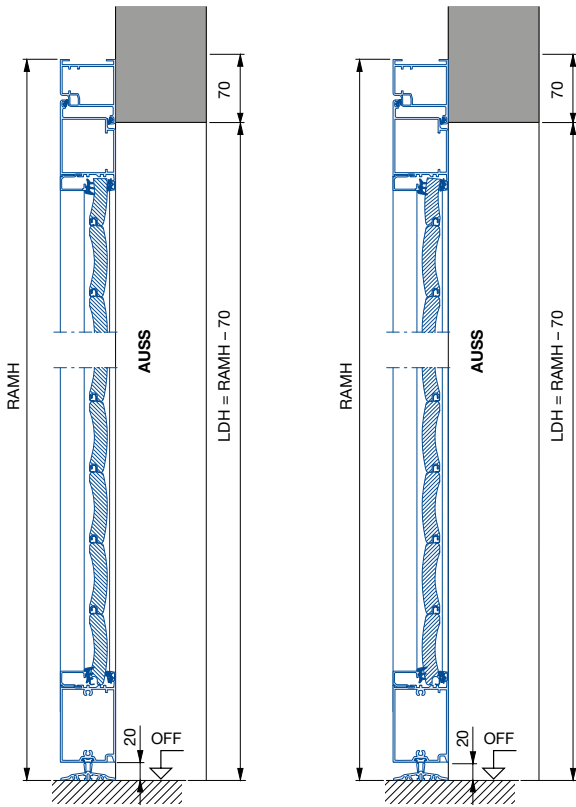

- AUSS** Exterior
- BRB** Nominal width
- BRH** Nominal height
- LMB** Structural opening width
- LMH** Structural opening height
- LDB** Clear passage width
- LDH** Clear passage height
- RAMB** Overall frame dimension width (ordering size)
- RAMH** Overall frame dimension height (ordering size)
- OFF** Finished floor level

NT 60 side doors

For roller garage door RollMatic / garage horizontal door RollMatic OD
Single-leaf side doors with block frame made of aluminium profiles



Product description

Subject to changes

Fitting dimensions

Fitting in the opening (opening outwards)

Matching
Internal roller garage
doors RollMatic
Garage horizontal doors
RollMatic OD

Matching
External roller garage
doors RollMatic

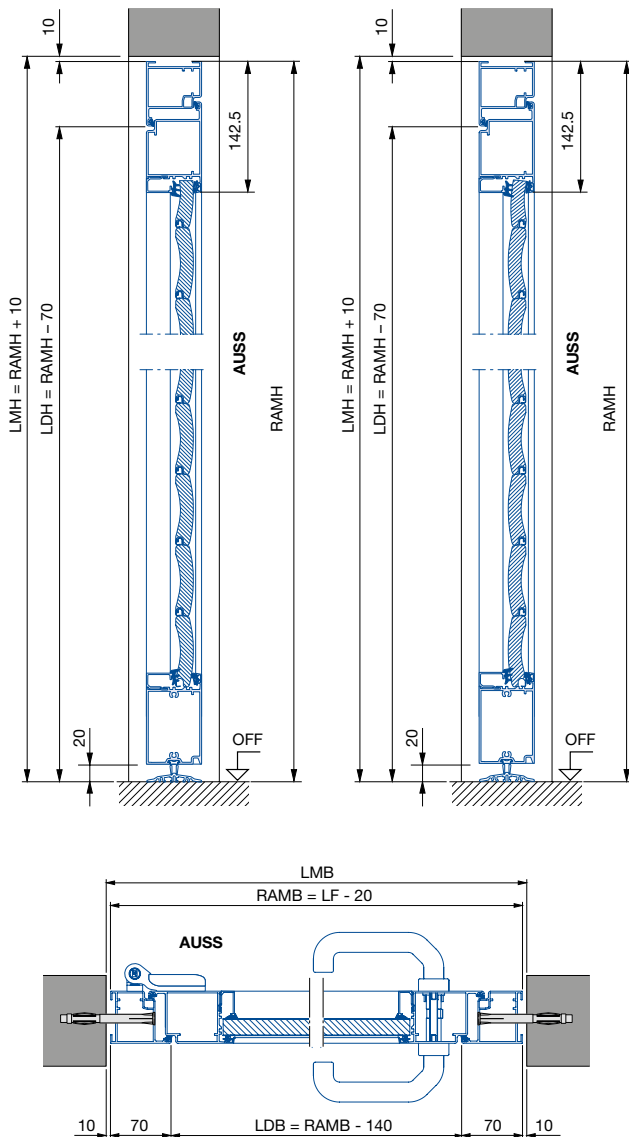



AUSS	Exterior
BMB	Ordering size width
BMH	Ordering size height
BRB	Nominal width
BRH	Nominal height
LMB	Structural opening width
LMH	Structural opening height
LDB	Clear passage width
LDH	Clear passage height
RAMB	Overall frame dimension width (ordering size)
RAMH	Overall frame dimension height (ordering size)
OFF	Finished floor level

NT 60 side doors

For roller garage door RollMatic / garage horizontal door RollMatic OD
Single-leaf side doors with corner frame made of aluminium profiles



Size range and prices

For a product description, see page 41			
Size range Ordering sizes Nominal sizes Width × Height			
	White or Colour	Golden Oak / Rosewood	Golden Oak or Rosewood
Opening inwards or outwards			
From 875 × 1800			
Up to 1200 × 2255	1188	1303	1504
From 1201 × 2256			
Up to 1284 × 2500	1240	1350	1574

Note:
View of internal roller garage door / external roller garage door, state opening sense and handing!



Noir 2100 Sablé			£
Door leaf / frame exterior and interior in colour Noir 2100 Sablé	Surcharge on white	Per door	367

NT 60 side doors

For roller garage door RollMatic / garage horizontal door RollMatic OD
Single-leaf side doors with block frame made of aluminium profiles

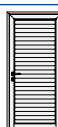

Size range and prices

For a product description, see page 41			
Size range Ordering sizes Overall frame dimensions (RAM) Width × Height			
	White or Colour	Golden Oak / Rosewood	Golden Oak or Rosewood
Opening inwards or outwards			
From 855 × 1800			
Up to 1200 × 2255	1201	1310	1519
From 1201 × 2256			
Up to 1330 × 2558	1240	1350	1574



Note:
View of internal roller garage door / external roller garage door, state opening sense and handing!

Noir 2100 Sablé			£
Door leaf / frame exterior and interior in colour Noir 2100 Sablé	Surcharge on white	Per door	367

Accessories and optional extras

For NT 60 side doors

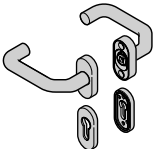
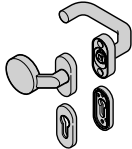
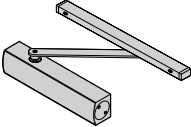
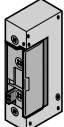
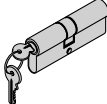

Glazing element		£
	Glazing element with clear synthetic pane, window cut-out 112 × 33 mm, black glazing frame on exterior, transparent on interior The number of glazing elements is dependent on the door width (not possible in the bottom section and in the lock area)	Per m 42
Ventilation grilles		£
	Ventilation grille, black plastic Ventilation cross section: approx. 13 cm ² / grille The number of ventilation grilles is dependent on the door width (not possible in the bottom section and in the lock area)	Per m 42
Smaller overall frame dimensions		£
	Side door in smaller dimensions than special sizes	Per door 560
Frame fixing (optional)		£
	Support bracket for block frame	Per set 35
	Screw-in anchor for corner frame	Per set 37
Fittings		£
Lever handle sets		
	Cast aluminium with natural finish (F1), prepared for profile cylinder	Each 156
	Cast aluminium in RAL 9016, prepared for profile cylinder	Each 190
	Cast aluminium in black, prepared for profile cylinder	Each 190
	Brushed stainless steel, prepared for profile cylinder	Each 206
Lever / knob handle sets		
	Black plastic, prepared for profile cylinder	Each 86
	Cast aluminium with natural finish (F1), prepared for profile cylinder	Each 181
	Cast aluminium in RAL 9016, prepared for profile cylinder	Each 226
	Cast aluminium in black, prepared for profile cylinder	Each 226
	Brushed stainless steel, prepared for profile cylinder	Each 239
Overhead door closer		
	Overhead door closer with slide rail and hold-open device	Each 359
3-point locking		
	3-point locking with latch, bolt, and 2 locking hooks; keys to differ Cannot be retrofitted!	Per door 549
Electric door strike with day and night setting (without wiring). For doors with block frame made of aluminium profiles.		
	10 – 24 V, LH hinged / RH hinged (only opens with an impulse, i.e. as long as the button is pressed)	Each 136
	10 – 24 V, LH hinged / RH hinged (remains open after impulse until the door is actuated, subsequent locking by door opener)	Each 181
Block reed contact		
	Block reed contact (article no. 4004810)	Each 133
Anti-panic locks		£
	Anti-panic lock function E For profile cylinders, for fixed knob on exterior; the door can only be opened from the outside using a key	Each 273
Profile double cylinder		£
	Profile double cylinder 40 + 40 mm Keys to pass, for side doors NT 60	on request

Garage Door Operators

Operator Accessories



Garage door operators





Boom Length	SupraMatic E	SupraMatic P	ProMatic	ProMatic Akku
K	647	719	524	859
M	682	754	559	894
L	794	866	671	1006

Hand transmitters with BiSecur technology are backwards compatible, i.e. they can also be used with series 1 and 2 operators (868 MHz). Hand transmitter 868 MHz BiSecur, incl. battery (Range of radio signal depends on local conditions)

- Possible
- Only in combination with a BiSecur radio receiver
- Only in conjunction with the BiSecur radio receiver ESE, status query possible
- Not possible

Garage door operators

SupraMatic E/P	SupraMatic HT	ProMatic	ProMatic Akku	RollMatic
----------------	---------------	----------	---------------	-----------

Accessory	Description	SupraMatic E/P	SupraMatic HT	ProMatic	ProMatic Akku	RollMatic
HS 1-button hand transmitter  Black HS 1 BS Art. no. 4511720 £ 77	Textured plastic surface with chrome-plated zinc die-cast caps <ul style="list-style-type: none"> • Impulse • Protection category: for dry rooms only • Temperature range: -20 °C to +60 °C • Battery: 1.5 V LR03 / AAA • Dimensions: 38 × 95 × 16 mm 	●	●	●	●	●
HS 4-button hand transmitter  Black HS 4 BS Art. no. 4511724 £ 77	Textured plastic surface with chrome-plated zinc die-cast caps <ul style="list-style-type: none"> • Impulse • Protection category: for dry rooms only • Temperature range: -20 °C to +60 °C • Battery: 1.5 V LR03 / AAA • Dimensions: 38 × 95 × 16 mm 	●	●	●	●	●
HS 5-button hand transmitter  Black HS 5 BS Art. no. 436946 £ 91	Textured plastic surface with chrome-plated zinc die-cast caps <ul style="list-style-type: none"> • Impulse • Status query • Protection category: for dry rooms only • Temperature range: -20 °C to +60 °C • Battery: 1.5 V LR03 / AAA • Dimensions: 38 × 95 × 16 mm 	●	●	●	●	-
HS 5-button hand transmitter  Black White HS 5 BS HS 5 BS Art. no. 436752 436753 £ 91 91	High gloss plastic surface with chrome-plated zinc die-cast caps <ul style="list-style-type: none"> • Impulse • Status query • Protection category: for dry rooms only • Temperature range: -20 °C to +60 °C • Battery: 1.5 V LR03 / AAA • Dimensions: 38 × 95 × 16 mm 	●	●	●	●	-



Garage Door Operators

Operator Accessories



Hand transmitters with BiSecur technology are backwards compatible, i.e. they can also be used with series 1 and 2 operators (868 MHz). Hand transmitter 868 MHz BiSecur, incl. battery (Range of radio signal depends on local conditions)

- Possible
- Only in combination with a BiSecur radio receiver
- Only in conjunction with the BiSecur radio receiver ESE, status query possible
- Not possible

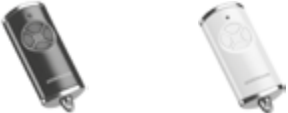
Accessory			Description	Garage door operators																							
				SupraMatic E/P	SupraMatic HT	ProMatic	ProMatic Akku	RollMatic																			
HSI Industrial hand transmitter  <p>Black Black Black</p> <p>HSI 3 BS HSI 6 BS HSI 15 BS</p> <p>Art. no. 635058 4511773 4511774</p> <p>£ 107 131 188</p>			<ul style="list-style-type: none"> Impulse Protection category: IP 65 <p>HSI 3 BS“</p> <ul style="list-style-type: none"> For controlling up to 3 receivers Dimensions (W x H x D): 36 x 74 x 16 mm Battery: 2 x CR2025 Temperature range: -10°C to +60°C Incl. belt clip and hand transmitter strap <p>HSI 6 BS“</p> <ul style="list-style-type: none"> For controlling up to 6 receivers Dimensions (W x H x D): 50 x 90 x 25 mm Battery: 2 x 1.5 V LR03 / AAA Temperature range: -20°C to +60°C Incl. belt clip and lanyard <p>HSI 15 BS“</p> <ul style="list-style-type: none"> For controlling up to 15 receivers Dimensions (W x H x D): 65 x 133 x 25 mm Battery: 4 x 1.5 V LR03/AAA Temperature range: -20°C to +60°C Incl. belt clip and lanyard 																								
Accessories Hand transmitter holder  <p>For HSI 3 BS For HSI 6 BS For HSI 15 BS</p> <p>Art. no. 635059 437383 437384</p> <p>£ 10 10 14</p>			<ul style="list-style-type: none"> Hand transmitter holder Fitting accessories for mounting to the wall or tubular frame 																								
HSE 1-button hand transmitter  <p>Black</p> <p>HSE 1 BS</p> <p>Art. no. 4511728</p> <p>£ 77</p>			<p>Textured plastic surface with chrome-plated zinc die-cast caps</p> <ul style="list-style-type: none"> Impulse Incl. key ring for fastening to the key chain Protection category: for dry rooms only Temperature range: 0 °C to +60 °C Battery: Lithium round cell 3 V / type CR 2032 Dimensions: 28 x 70 x 14 mm 																								
HSE 4-button hand transmitter  <p>Black White</p> <p>HSE 4 BS HSE 4 BS</p> <p>Art. no. 4511561 4511565</p> <p>£ 77 77</p>			<p>High-gloss plastic surface with chrome-plated zinc diecast caps</p> <ul style="list-style-type: none"> Impulse Incl. key ring for fastening to the key chain Protection category: for dry rooms only Temperature range: 0 °C to +50 °C Battery: Lithium round cell 3 V / type CR 2032 Dimensions: 28 x 70 x 14 mm 																								
HSE 4-button hand transmitter HSE 4 BS <table border="1"> <thead> <tr> <th>Housing colour</th> <th>Art. no.</th> <th>£</th> </tr> </thead> <tbody> <tr> <td>Anthracite grey</td> <td>4511573</td> <td>91</td> </tr> <tr> <td>Frozen grey</td> <td>4511569</td> <td>91</td> </tr> <tr> <td>Classic grey</td> <td>4511577</td> <td>91</td> </tr> <tr> <td>Carbon</td> <td>4511585</td> <td>91</td> </tr> <tr> <td>Silver</td> <td>4511581</td> <td>91</td> </tr> </tbody> </table>			Housing colour	Art. no.	£	Anthracite grey	4511573	91	Frozen grey	4511569	91	Classic grey	4511577	91	Carbon	4511585	91	Silver	4511581	91							
Housing colour	Art. no.	£																									
Anthracite grey	4511573	91																									
Frozen grey	4511569	91																									
Classic grey	4511577	91																									
Carbon	4511585	91																									
Silver	4511581	91																									

Garage Door Operators

Operator Accessories









Hand transmitters with BiSecur technology are backwards compatible, i.e. they can also be used with series 1 and 2 operators (868 MHz). Hand transmitter 868 MHz BiSecur, incl. battery (Range of radio signal depends on local conditions)

- Possible
- Only in combination with a BiSecur radio receiver
- Only in conjunction with the BiSecur radio receiver ESE, status query possible
- Not possible

Garage door operators

SupraMatic E/P	SupraMatic HT	ProMatic	ProMatic Akku	RollMatic
----------------	---------------	----------	---------------	-----------

Accessory	Description	SupraMatic E/P	SupraMatic HT	ProMatic	ProMatic Akku	RollMatic
HSE 4-button hand transmitter  Black HSE 4 BS Art. no. 4511732 £ 77	Textured plastic surface with chrome-plated zinc die-cast caps <ul style="list-style-type: none"> • Impulse • Incl. key ring for fastening to the key chain • Protection category: for dry rooms only • Temperature range: 0 °C to +60 °C • Battery: Lithium round cell 3 V / type CR 2032 • Dimensions: 28 × 70 × 14 mm 	●	●	●	●	●
HSE 4-button hand transmitter  Black HSE 4 BS Art. no. 4511736 £ 70	Textured plastic surface with plastic caps <ul style="list-style-type: none"> • Impulse • Incl. key ring for fastening to the key chain • Protection category: for dry rooms only • Temperature range: 0 °C to +60 °C • Battery: Lithium round cell 3 V / type CR 2032 • Dimensions: 28 × 70 × 14 mm 	●	●	●	●	●
Accessories For hand transmitter (HSE)  Hand transmitter holder Art. no. 437006 £ 13	<ul style="list-style-type: none"> • For HSE 1 BS, HSE 2 BS and HSE 4 BS • Transparent, incl. visor clip • For wall fitting or for fitting to the visor clip • without fixing material 					
HSD  Chrome HSD 2-C BS Art. no. 436775 £ 110	<ul style="list-style-type: none"> • Impulse • High-quality metal housing • As a key ring • Protection category: for dry rooms only • Temperature range: 0 °C to +60 °C • Battery: Lithium round cell 3 V / type CR 2025 • Dimensions (W × H × D): 32 × 66 × 13 mm 	●	●	●	●	●
HSZ 1-button hand transmitter 2-button hand transmitter   Black Black HSZ 1 BS HSZ 2 BS Art. no. 436779 436782 £ 70 70	<ul style="list-style-type: none"> • Impulse • For insertion in a vehicle cigarette lighter • Protection category: for dry rooms only • Temperature range: -20 °C to +60 °C • Battery: Lithium 3 V / type CR 2 • Dimensions (D × H): Ø 29 × 39 mm 	●	●	●	●	●

Garage Door Operators

Operator Accessories







Hand transmitters with BiSecur technology are backwards compatible, i.e. they can also be used with series 1 and 2 operators (868 MHz). Hand transmitter 868 MHz BiSecur, incl. battery (Range of radio signal depends on local conditions)

- Possible
- Only in combination with a BiSecur radio receiver
- Only in conjunction with the BiSecur radio receiver ESE, status query possible
- Not possible

Garage door operators

SupraMatic E/P	SupraMatic HT	ProMatic	ProMatic Akku	RollMatic
----------------	---------------	----------	---------------	-----------

Radio internal push button / internal receiver							
FIT	1-button radio internal push button	<ul style="list-style-type: none"> • Protection category: for dry rooms only • Temperature range: -20 °C to +60 °C • Battery: 2 x 1.5 V LR03 / AAA • Colour: Pure white RAL 9010 • Dimensions (W x H x D): 80 x 80 x 15 mm • Screw and adhesive fixing 					
Art. no.	FIT 1 BS 439740						
£	115						
FIT	4-button radio internal push button	<ul style="list-style-type: none"> • Impulse • Protection category: for dry rooms only • Temperature range: -20 °C to +60 °C • Battery: 2 x 1.5 V LR03 / AAA • Colour: Pure white RAL 9010 • Dimensions (W x H x D): 80 x 80 x 15 mm • Screw and adhesive fixing 					
Art. no.	FIT 4 BS 439741						
£	115						
FIT	5-button radio internal push button	<ul style="list-style-type: none"> • Impulse • Status query • Protection category: for dry rooms only • Temperature range: -20 °C to +60 °C • Battery: 2 x 1.5 V LR03 / AAA • Colour: Pure white RAL 9010 • Dimensions (W x H x D): 80 x 80 x 15 mm • Screw and adhesive fixing 					
Art. no.	FIT 5 BS 439742						
£	133						
FES	Radio receiver electric socket	<ul style="list-style-type: none"> • For Hörmann door operators and operators of other makes to switch lights and other consumers on and off • Functions: <ul style="list-style-type: none"> – Impulse, switching (On / Off), selective switching on or off, status feedback – Impulse for door operators (0.5 s), without operator status feedback • Protection category: IP 20 • Standby: < 0.5 W • Temperature range: -20 °C to +35 °C • Operating voltage: 100 – 240 V AC • Electric socket switching capacity: <ul style="list-style-type: none"> – 2500 W / 10 A resistive load – 500 W inductive load • Impulse output switching capacity: volt-free normally open contact max. • 24 V / max. 110 mA • With connection cable 1 x 2 m, 2-wire • Colour: Pure white RAL 9010 • Dimensions (W x H x D): 80 x 80 x 67 mm 					
Art. no.	FES 1-1 BS 439763						
£	151						

Garage Door Operators

Operator Accessories



Hand transmitters with BiSecur technology are backwards compatible, i.e. they can also be used with series 1 and 2 operators (868 MHz). Hand transmitter 868 MHz BiSecur, incl. battery (Range of radio signal depends on local conditions)

- Possible
- Only in combination with a BiSecur radio receiver
- Only in conjunction with the BiSecur radio receiver ESE, status query possible
- Not possible

Garage door operators

SupraMatic E/P	SupraMatic HT	ProMatic	ProMatic Akku	RollMatic
----------------	---------------	----------	---------------	-----------

Radio internal push button 868 MHz BiSecur, incl. battery (Range of radio signal depends on local conditions)

FCT Radio code switch



FCT 3-1 BS

Art. no. 4511857
£ 136

- Impulse
- for control of up to 3 door operators
- Illuminated keyboard
- Activation on push of button
- Protection category: IP 44
- Temperature range: -20°C to +50°C
- Power supply: Battery 2 × 1.5 V LR03 / AAA
- Housing: Plastic, colour Light grey RAL 7040

FCT 3-1 BS (recessed):

- Dimensions (W × H × D): 80 × 80 × 15 mm

FCT 3-1 BS (surface-mounted):

- Dimensions (W × H × D): 80 × 80 × 30 mm

●	●	●	●	●
---	---	---	---	---

FCT Radio code switch



FCT 10-1 BS

Art. no. 4511862
£ 205

- Impulse
- for control of up to 10 door operators
- Illuminated keyboard, hinged lid
- Automatic activation on opening the lid or by pushing the button
- Protection category: IP 44
- Temperature range: -20°C to +50°C
- Power supply: Battery 2 × 1.5 V LR03 / AAA
- Housing: Plastic, painted, colour White aluminium RAL 9006

FCT 10-1 BS (recessed):

- Dimensions (W × H × D): 80 × 80 × 20 mm

FCT 10-1 BS (surface-mounted):

- Dimensions (W × H × D): 80 × 80 × 35 mm

●	●	●	●	●
---	---	---	---	---

CTR Code switch



1 relay output 3 separate relay outputs

CTR 1b-1

CTR 3b-1

Art. no. 4511671 4511672
£ 250 288

- Impulse
- Illuminated keyboard
- With 5 m connecting cable between the input unit and the decoder
- Operating voltage: optionally 100–240 V AC or 10–24 V AC/DC
- Max. switching capacity:
 - 30 V DC / 2.5 A (resistive load)
 - 230 V AC / 500 W (resistive load)
- Protection category:
 - Input unit IP 65
 - Decoder unit IP20
- Temperature range: -20°C to +60°C
- Input unit dimensions (W × H × D): 80 × 80 × 15 mm
Decoder unit dimensions (W × H × D): 140 × 130 × 50 mm
- Without connecting lead, connection cables for power supply
 - 230 V AC: Use connection cable ZL 1
 - 24 V AC / DC and for providing impulse to operator: Use ASL connection cables. Use ASL connection cables
- **CTR 1b-1: 1** relay output for control of one door operator
CTR 3b-1: 3 separate relay outputs for control of 2 operators, second opening height, outdoor lighting

●	●	●	●	●
---	---	---	---	---

CTP Code switch



3 separate relay outputs

CTP 3-1

Art. no. 4511674
£ 343

- Illuminated capacitive keyboard
- Impulse
- With 5 m connecting cable between the input unit and the decoder
- Operating voltage: optionally 100–240 V AC or 10–24 V AC/DC
- Max. switching capacity:
 - 30 V DC / 2.5 A (resistive load)
 - 230 V AC / 500 W (resistive load)
- 3 separate relay outputs for control of 2 operators, second opening height, outdoor lighting
- Protection category:
 - Input unit IP 65
 - Decoder unit IP20
- Temperature range: -20°C to +60°C
- Input unit dimensions (W × H × D): 80 × 80 × 15 mm
Decoder unit dimensions (W × H × D): 140 × 130 × 50 mm
- Without mains lead, connection cables for power supply
 - 230 V AC: Use connection cable ZL 1
 - 24 V AC / DC and for providing impulse to operator: Use ASL connecting leads

●	●	●	-	●
---	---	---	---	---

Garage Door Operators

Operator Accessories



Hand transmitters with BiSecur technology are backwards compatible, i.e. they can also be used with series 1 and 2 operators (868 MHz). Hand transmitter 868 MHz BiSecur, incl. battery (Range of radio signal depends on local conditions)

- Possible
- Only in combination with a BiSecur radio receiver
- Only in conjunction with the BiSecur radio receiver ESE, status query possible
- Not possible

Garage door operators

SupraMatic E/P	SupraMatic HT	ProMatic	ProMatic Akku	RollMatic
----------------	---------------	----------	---------------	-----------

Radio internal push button 868 MHz BiSecur, incl. battery (Range of radio signal depends on local conditions)

FIT Radio internal push button



- Impulse
- With 2 impulse push buttons for control of 2 operators via radio signal
- One additional button for On/Off function of connected external control elements
- Connection option for max. 2 control elements (volt-free contact) e.g. key switch
- Protection category: for dry rooms only
- Temperature range: -20°C to +60°C
- Battery: 2 x 1.5 V LR03/AAA
- Colour: Pure white RAL 9010
- Dimensions (W x H x D): 80 x 80 x 45 mm

FIT 2-1 BS

Art. no. 4511695
£ 105

IT 3b-1 Internal push button



- Impulse
- Additional buttons for light on/off and operator on/off (vacation mode)
- Illuminated keyboard
- With 7 m connection cable, 2-wire
- Protection category: for dry rooms only
- Temperature range: -20°C to +60°C
- Colour: Pure white RAL 9010
- Dimensions (W x H x D): 80 x 80 x 45 mm

IT 3b-1

Art. no. 4511647
£ 53

Radio finger-scan 868 MHz BiSecur (range of radio signal depends on local conditions!)

FFL Radio finger-scan



- Impulse
- To control up to 2 door operators using a fingerprint
- Up to 25 fingerprints can be taught in, cannot be individually deleted
- Hinged lid
- Automatic activation on opening the lid or by pushing the "ON" button
- Protection category: IP 44
- Temperature range: -20°C to +50°C
- Power supply: Battery 2 x 1.5 V LR03/AAA
- Housing: Plastic, painted, colour White aluminium RAL 9006

FFL 25 BS (recessed):

- Dimensions (W x H x D): 80 x 80 x 20 mm

FFL 25 BS (surface-mounted):

- Dimensions (W x H x D): 80 x 80 x 35 mm

FFL 25 BS

Art. no. 4511865
£ 270

Batteries

Description

HNA Emergency battery



- Emergency power supply to bypass power failures up to 18 hours and max. 5 door cycles (depending on temperatures, situation of charge etc.)
- To be fixed on operator or garage ceiling
- Protection category: for dry rooms only
- Weight: approx. 2.3 kg
- Operating voltage: 24 V DC / 2.3 Ah
- Dimensions (W x H x D): 150 x 70 x 90 mm

Also suitable for series 2 SupraMatic and ProMatic operators.

HNA 18-3

Art. no. 437726
£ 270

HNA Emergency battery



- Emergency power supply to bridge power outages
- Universal fixing for wall and floor fitting
- Double LED function display
- Protection category: IP 65
- Weight: approx. 3 kg
- Dimensions: 213 x 143 x 96 mm
- Battery voltage: 24 V DC / 2.3 Ah

For RotaMatic/P/PL from autumn 2010 and for LineaMatic/P/H from year of manufacture 10/2009.

HNA Outdoor

Art. no. 436522
£ 285



Key switch posts / lighting technology

- Possible
- Only in conjunction with a BiSecur radio receiver
- Only in conjunction with the BiSecur radio receiver ESE, status query possible
- Not possible



Garage door operators

SupraMatic E / P	SupraMatic HT	ProMatic	ProMatic Akku	RollMatic
------------------	---------------	----------	---------------	-----------

LED light strips – variant overview

LED light strips can also be used for windows, doors or other applications independent of garage doors.

LED light strips

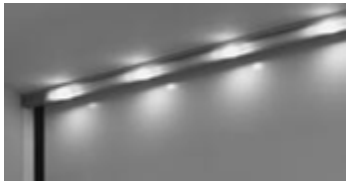

- Light colour: neutral white
- For fitting to the garage door leaf, below the garage lintel or side door
- The LEDs are fitted on the light strip at a distance of 125 mm from each other and provide indirect lighting of the side door or garage door
- Can be cut to size
- Protection category: IP 65
- Can be optionally switched in conjunction with SupraMatic E, P, HT (HOR 1 or UAP 1 required)
- Can be optionally switched in conjunction with ProMatic and RollMatic (PR 1 required)

Dimensions in mm (from – to)		Art. no.	£
Lintel fitting	Door leaf fitting		
1000 – 1250*	1000 – 1250*	436550	145
2000 – 2500	2000 – 2625	436551	215
2625 – 3000	2750 – 3125	436552	306
3125 – 3500	3250 – 3625	436553	335
3625 – 4250	3750 – 4375	436554	375
4375 – 4500	4500 – 4625	436555	450
4625 – 4750	4750 – 4875	436556	465
4875 – 5250	5000 – 5375	436557	493
5375 – 6000	5500 – 6125	436558	538
6125 – 6250	6250 – 6375	436559	612
6375 – 6500	6500 – 6625	436560	628

Note:

- Power supply unit (article no. 436534) is also required and must be ordered separately!

Accessories	For LED light strip (not shown)
	Power supply unit
Art. no.	436534
£	46

- Required to supply the LED light strip on the lintel or door leaf with power
- 230 V AC / 6 V DC / 12 W

Notes:

- For fitting to the garage door leaf, the door leaf activating kit AT 3 (article no. 638296) is additionally required!
- For fitting to the lintel, a junction box (article no. 436535) is required!

	For LED light strip
	Art. no.
Activating kit for door leaf AT 3	638296
Junction box	436535

●	●	●	●	●



SmartHome

- Possible
- Only in conjunction with a BiSecur radio receiver
- Only in conjunction with the BiSecur radio receiver ESE, status query possible
- Not possible



Garage door operators

SupraMatic E / P	SupraMatic HT	ProMatic	ProMatic Akku	RollMatic
------------------	---------------	----------	---------------	-----------

Hörmann homee

Hörmann homee



**Basic cube
Hörmann homee Brain**

Art. no. 4510276
£ 391

- Hörmann homee Brain basic cube with BiSecur radio system for operating Hörmann garage door and entrance gate operators, entrance door locks and electronic devices with BiSecur radio
- Protection category: for dry rooms only
- Power supply: 100–240 V AC, 50/60 Hz, 200 mA
- Secondary voltage: 5 V DC / 1.2 A
- Temperature range: -20 °C to +60 °C
- Operating voltage: 24 V DC
- Housing: plastic
- Colour: Pure white RAL 9010
- Dimensions (W x H x D): 51 x 51 x 53 mm
- Scope of delivery: power supply unit 100–240 V AC
- Administration via Hörmann homee app (iOS, Android) and web app
- System requirements:
 - iOS devices from version 12.0 or higher
 - Android devices from software version 5.0 or higher
 - Web interface (current version), Internet Explorer, Safari, Google Chrome or Mozilla Firefox
- WLAN (802.11b/g/n)
- LAN possible via LAN adapter
- Hörmann homee app
 - Operation via the home network or globally via the Internet
 - Control of individual devices, device groups or via programmable "homeegram" scenarios
 - Supports all BiSecur devices
 - Expandable by various standard radio protocols (cubes) for additional elements (light, alarm system, heating etc.), such as ZigBee, Z-Wave, EnOcean
 - Weather with forecast can be used in homeegrams (scenarios)
 - Voice assistants Alexa, Google Assistant and Siri (shortcuts)

● ● ● ● ●

LAN adapter



LAN adapter for Hörmann homee

Art. no. 437299
£ 40

- LAN adapter for Hörmann homee Brain

Warranty

Hörmann products are manufactured to the highest quality standards and leave our factory only after rigorous quality testing. However, if you should have grounds for complaint, this section tells you what our door warranty offers, and how to go about making your claim.

In the unlikely event of a warranty claim becoming necessary, please contact the dealer or distributor who originally supplied your garage door. Your dealer should then supply details of the claim, together with a copy of the warranty card provided with the door and proof of purchase to the Product Services Department at Hörmann (UK) Ltd. To enable your claim under warranty to be processed as quickly as possible, you should provide the following details:

1. Your name, address and telephone number
2. Original invoice with date of purchase
3. Product description/door type and product number
4. Description of defect

An assessment of the claim will then be made. This may require Hörmann to inspect the product in-situ. In the event that there is no legitimate warranty claim under the terms specified herein, you may be liable for the costs of the inspection visit. We strongly recommend that you take note of the care and usage instructions displayed on the stickers on the back of your garage door, and on the page opposite, and that you follow these instructions throughout.

Hörmann installers

Hörmann (UK) Ltd has a nationwide network of recommended installers who will be able to offer you a regular maintenance service on your garage door. Please call us on 01530 513050 for details of your nearest dealer.

The Quality Check

A new garage door can be a significant investment that will transform the appearance of your home. This information is a guide to the quality you can expect.

Hörmann (UK) Ltd Garage Door Warranty

Warranty Period	The purchaser is granted a warranty covering the safe and reliable function of the Hörmann garage door for a period of 10 years from the date of purchase. A 5 year warranty applies to springs, wire cables, track rollers, hinges and guide rollers. The warranty period for replacement parts is 6 months or to the end of the current warranty period, whichever is longer. In the case of foil-coated timber-effect, a warranty of 5 years is granted, for timber a warranty of 2 years is granted on the door panels alone under the terms and conditions specified herein. The door mechanism and steel frame (if applicable) is covered by the 10 year warranty period.
Requirements	Warranty claims are only applicable in the country where the garage door was purchased. The product must have been purchased through our authorised distribution channels. The warranty only covers damage to the contract object. The fully completed warranty card together with the receipt of purchase correspondingly dated substantiates your right to claim under the warranty.
Performance	During the warranty period we undertake to rectify any and all defects to the Hörmann product which can be proved to be attributed to a material or manufacturing fault. We pledge at our discretion either to exchange the defective merchandise for faultless merchandise, repair it or allow a reduction in price. We do not accept costs for dismantling and installation nor for carriage. Replaced parts become our property. The warranty does not cover damage caused through: <ul style="list-style-type: none">• normal wear and tear• improper installation• negligent care and maintenance• improper initial and subsequent operation• negligent or wanton destruction• external influences such as fire, water, salts, alkaline solutions, acids, abnormal environmental influences• mechanical damage through improper transport and fitting• priming and other surface protection treatments• incorrect or too late applied surface protection treatments• repair by non-qualified persons• using non-Hörmann parts without the approval of the manufacturer• removal of the product number or making it unidentifiable

Electric Operator Warranty

A separate 5 year warranty is granted on our electric operators. This includes operator mechanics, motor and motor control systems. A 2 year warranty is granted on radio equipment, accessories and system controls. There is no warranty on consumables (e.g. fuses, batteries, bulbs etc.). For further details please contact us on 01530 513030 or through our website on www.hormann.co.uk

User Information/Care

Finish – Steel Doors

The coating process applied to the door and chassis is environmentally friendly. Minor scratches or marks are not covered under the conditions of our warranty and should be repaired immediately to prevent corrosion and deterioration of the panel. Corrosive substances such as acids, alkalines, and salts, etc. should be cleaned from the door immediately; failure to do so will result in deterioration of the finish, which will not be covered under our warranty. Should deterioration of the finish start to occur you will need to repaint your door immediately. Prepare the surface lightly with wet and dry. Then treat with solvent based 2 pack epoxy wash primer and a normal commercial paint (cellulose paint must not be used). Hörmann steel doors are a finished product. They do not require re-painting on site. They are however not immune to damage, which can occur at any stage of the handling of the product from factory to site.

Finish – Timber Doors

Timber panels are coated with a neutralising base-stain. Doors must be stored upright, under cover, with wrapping intact, until wrapping is removed. As soon as the door is unwrapped, one coat of a good quality basecoat primer must be applied to both sides of the door. Immediately after installation, your timber doors require a further two coats of a good quality exterior wood finish on both sides. Initial application and periodic treatment should be carried out strictly in accordance with the woodstain manufacturer's instructions. Failure to follow these instructions will result in early deterioration of the timber panel.

Paint Finish – Steel Doors

Minor surface damage can easily be repaired using touch up sprays or sticks without invalidating warranties.

The following document was designed by the Association of Garage Door Specialists, updated by the DHF and endorsed by all major UK garage door manufacturers, as a guide for purchasers of domestic garage doors.

Visual appearance of Garage Doors

A new garage door can be a significant investment that will transform the appearance of your home. This information is a guide to the quality you can expect.

The Quality Check

The quality check should be carried out in natural daylight, not direct sunlight. Stand at a distance of 3 metres from the door to view the overall appearance. The door is acceptable if, taking into account the facts below, none of the following are readily visible on the face of the door:

- Marks or distortion associated with the manufacturing process
- Minor indentations, marks or scuffs on the surface
- Paint or stain blemishes

The Facts

Steel Doors

Panel Distortion	The rolling or pressing of steel panels during manufacture will cause distortion in the steel and while every effort is made to keep this to a minimum, inevitably some visible distortion will remain. The application of high gloss paints will make this slight distortion more apparent, especially under certain lighting conditions, such as car headlamps, or bright sunshine.
Paint Finish	Primed doors – the primer coating is applied as a base coat only and as such requires additional finishing with a good quality exterior paint. Any marks or scratches on the primer coat should be rubbed down and repainted as part of this finishing process.
Timber Doors	Finished doors – the factory application of the paint finish is an automated process and this may result in minor blemishes or slight inconsistencies in the paint, particularly in the area of panel joints.

Timber

Timber is a natural product and there will be variations in pattern, colour, shading and grains. No two doors will be the same, because wood naturally expands and contracts according to environmental conditions, joints will open and close and some minor curvature may occur.

It is vital that timber doors are fully finished as per the manufacturers instructions before exposure to the elements.

All Doors

Colour Match	Pairs of doors should be ordered together to obtain the best colour match, bearing in mind the limitations of the materials used in the construction. Timber garage doors cannot be ordered as matching sets.
Size Variation	As the size of a door changes in height and/or width, the panel frequency and profile can change, therefore doors of the same style but of different sizes can be significantly different in appearance.
Clearances	All doors require operating clearances, i.e. the gap between the door panel and the frame opening, these are inbuilt during manufacture and should not be reduced by means of infills, or draughtproofing.
Deflection	When in the open position, all doors will display a level of vertical deflection or “sag” across the width of the panel. Individual manufacturers' specifications should be consulted for exact tolerances.

Power Operated Garage Doors

It is against the law to install a power operated garage door in the UK without complying with the Machinery Directive.

To comply with the Machinery Directive both the door and the operator used in the installation must have a Declaration of Incorporation from the manufacturer.

On completion of the installation the installer must provide a Declaration of Conformity and apply a CE mark giving details of the installation to the door/operator combination, which is now classed as a machine.

The installer must issue to the customer a Declaration of Conformity on completion of the installation.

The installer must hold copies of both the Declaration of Incorporation and the Declaration of Conformity on a technical file for inspection by the relevant authorities.

If any of the above requirements are not fulfilled the installation is illegal.

Please ensure for your own safety and peace of mind that whoever installs your electric operator is both willing and able to fulfil these requirements; if they are not – do not use them!

Members of the DHF Garage Door Installer Group can and will install your Hörmann operator safely and legally.

Since the company's policy is one of continuous improvement of its products, we reserve the right to make any alterations in design, manufacture or price. All business is governed by the company's Standard Conditions and this document does not form any part of any contract with the company and statements contained in it should not be construed as representations or warranties.

Brand quality for residential and commercial construction

The family-owned company Hörmann offers all important construction components for building and renovating projects from a single source. We manufacture in highly-specialised factories using state-of-the-art production technologies. Furthermore, our employees work intensively on new products, continual further developments and improvements to details. The results are patents and one-of-a-kind products you can depend on.

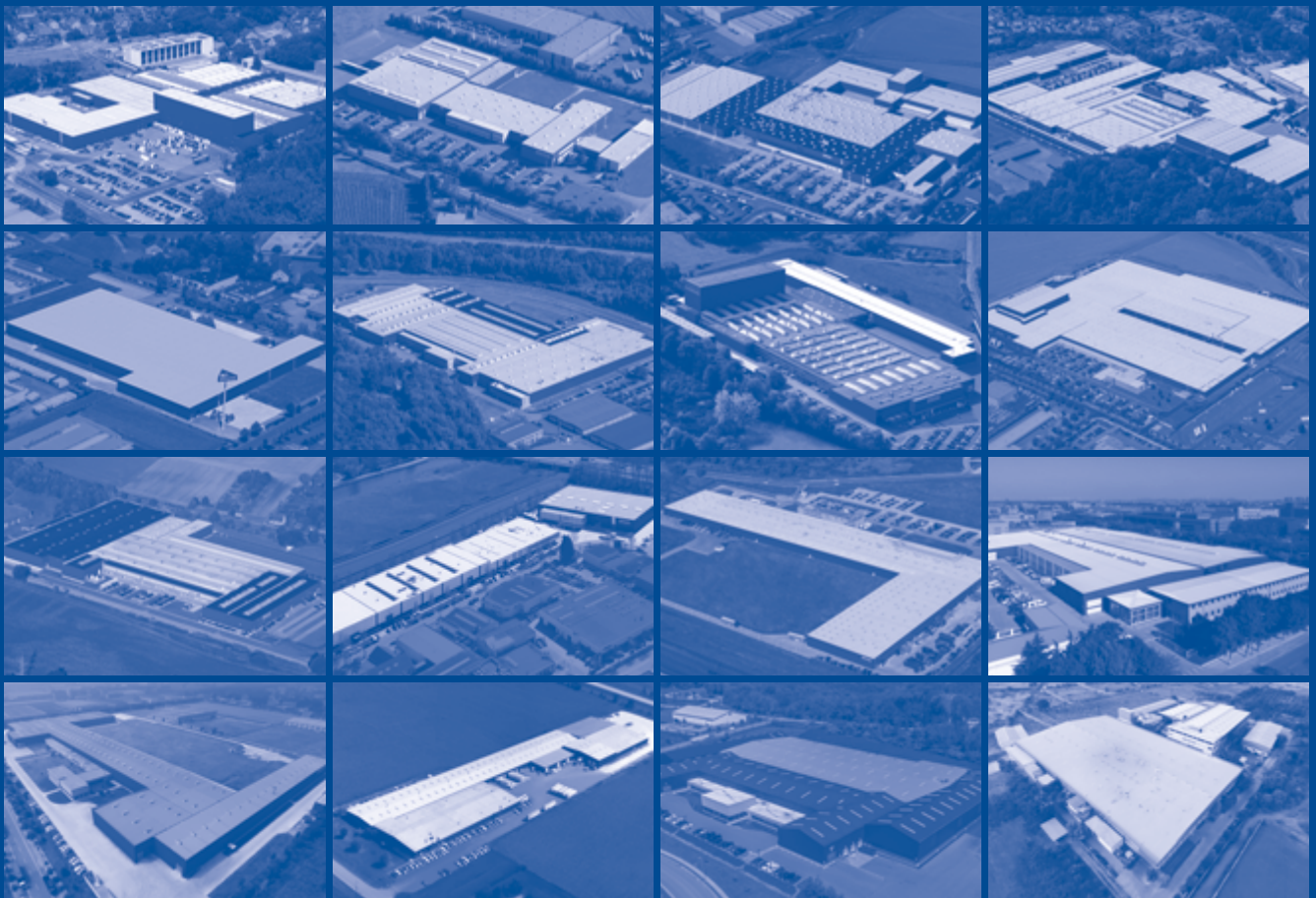

01.03.2024 V.2

www.hormann.co.uk

Hörmann (UK) Ltd
Gee Road
Coalville
Leicestershire
LE67 4JW

Tel: 01530 513000
Fax: 01530 513001

www.hormann.co.uk

HÖRMANN